



Nature is our
greatest home
and a timeless
source of
inspiration not
just for its
visual beauty
but also as a
guiding
philosophical
approach to life.



Furniture design with a strong visual identity that invites conviviality. A fusion of functionality, innovation and beauty that evokes a perfect balance between timeless elegance and contemporary dynamism.

Every YAAZ product is the result of a constant quest for innovation, where advanced technical solutions are combined with a design that responds to the needs of the people who live in the spaces. The combination of fine materials and cutting-edge technology offers beautiful and well-made products, with intelligent design solutions and refined finishes that enhance both ease of use and contemporary beauty.

YAAZ offers a complete furniture collection, designed in Italy to integrate perfectly into any type of architectural space, both indoor and outdoor. Whether for private residences, luxury hotels, exclusive resorts, elegant workspaces, expansive gardens or high-class yachts, YAAZ products are ideal for transforming any environment into a refined and welcoming space.

The YAAZ factory is structured according to the highest standards of excellence, combining advanced numerical control technologies and high craftsmanship to create products that meet the highest standards of the global market.

BARLA



ANKA

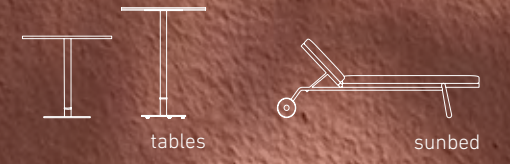

TURTLE



ADA

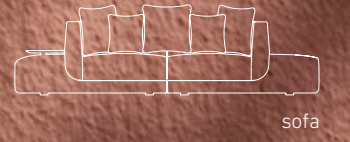

UZ



FESS

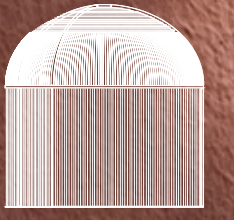

DENK

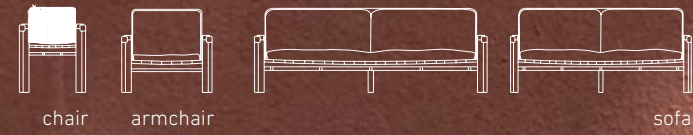

RASEL

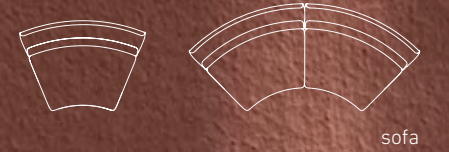

OVA



complements

EDI



HAYAL

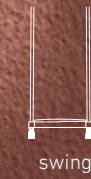

HISS



MONTE



SINI



HARR



SEMT

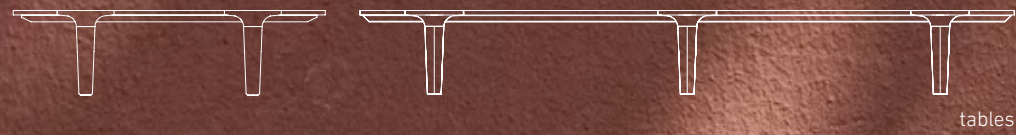

YUNN

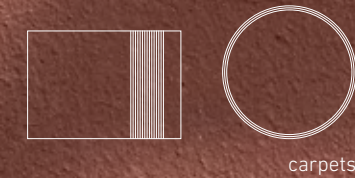

KUVA



SAYE



MANLE



SWEET

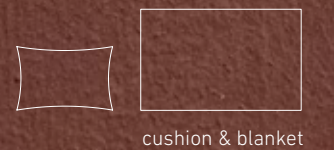

DEDIM

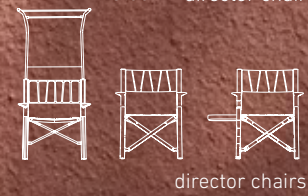



index

collections

BARLA	pg. 10
TURTLE	pg. 26
UZ	pg. 44
DENK	pg. 72
OVA	pg. 84
EDI	pg. 98
MONTE	pg. 104
SEMT	pg. 110
SAYE	pg. 116
DEDIM	pg. 122
ANKA	pg. 132
ADA	pg. 138
FESS	pg. 144
RASEL	pg. 150

complements

HAYAL	pg. 156
HISS	pg. 162
SINI	pg. 168
HARR	pg. 172
YUNN	pg. 176
KUVA	pg. 180
MANLE	pg. 184
SWEET	pg. 188

technical pages

Finishes	pg. 194
Fabrics	pg. 211
Technical info	pg. 218

BARLA collection

angelettiruzza design

Aluminium and rope
meet to create the
iconic BARLA collection.





Generous aesthetics, combined with a wraparound design conceived for maximum well-being, make the BARLA collection the ideal choice for those who wish to experience their outdoor spaces with casual elegance, without sacrificing functionality or total comfort.



Solid and durable, our products are created to bring beauty and harmony to the world.

barla sofa

The BARLA collection seems to be suspended in the air, as if seeking direct contact with the sky, but at the same time it is deeply rooted in the earth. This duality, between lightness and solidity, between high and low, is its distinctive essence.

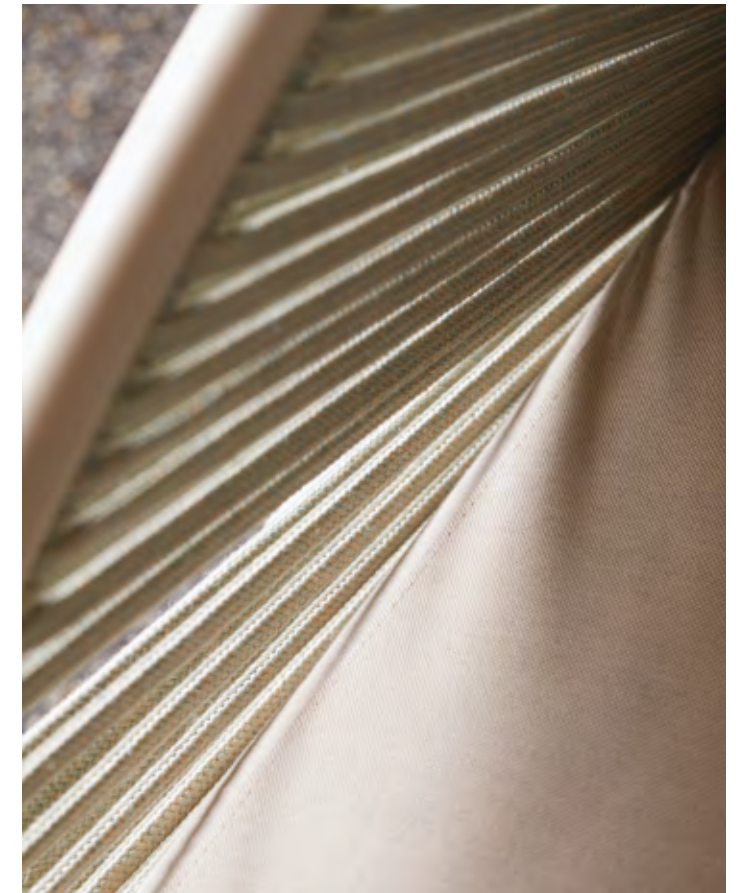



barla armchair



The BARLA collection offers endless style possibilities, thanks to the ability to play with the colors of the ropes and aluminum. In its monochromatic version, BARLA exudes sobriety and timeless elegance, with neutral tones that seamlessly blend into any environment. The purity of its lines and the simplicity of its forms are showcased in their full beauty, evoking a sense of calm and tranquility.



barla club chair



The BARLA club chair, with its cozy and comfortable shape, is the perfect addition to lounge areas in hotels and resorts. Inspired by the softness of a cocoon, its design creates an intimate and relaxing atmosphere, ideal for convivial spaces.

barla chair

BARLA reveals a Mediterranean, sunny soul energetic and lively when featuring bright, vibrant colors for the ropes and aluminum. Each space can be uniquely interpreted and personalized, thanks to the wide selection of colors.





The BARLA table is not just a surface for eating, playing, or working, but a platform for natural, fluid interaction and enjoyment. The harmonious shapes and the combination of different materials emphasize its versatility, making it a product that reflects the evolving uses and behaviors of contemporary society.



barla table





barla bar stool & counter

Made of high-quality stainless steel, the footrest offers excellent resistance to scratches and abrasions that could damage the aesthetics of the product with frequent use.



TURTLE collection

YAAZ lab

The TURTLE collection is inspired by the sweetness of childhood memories, featuring teak wood, aluminum, and ropes.

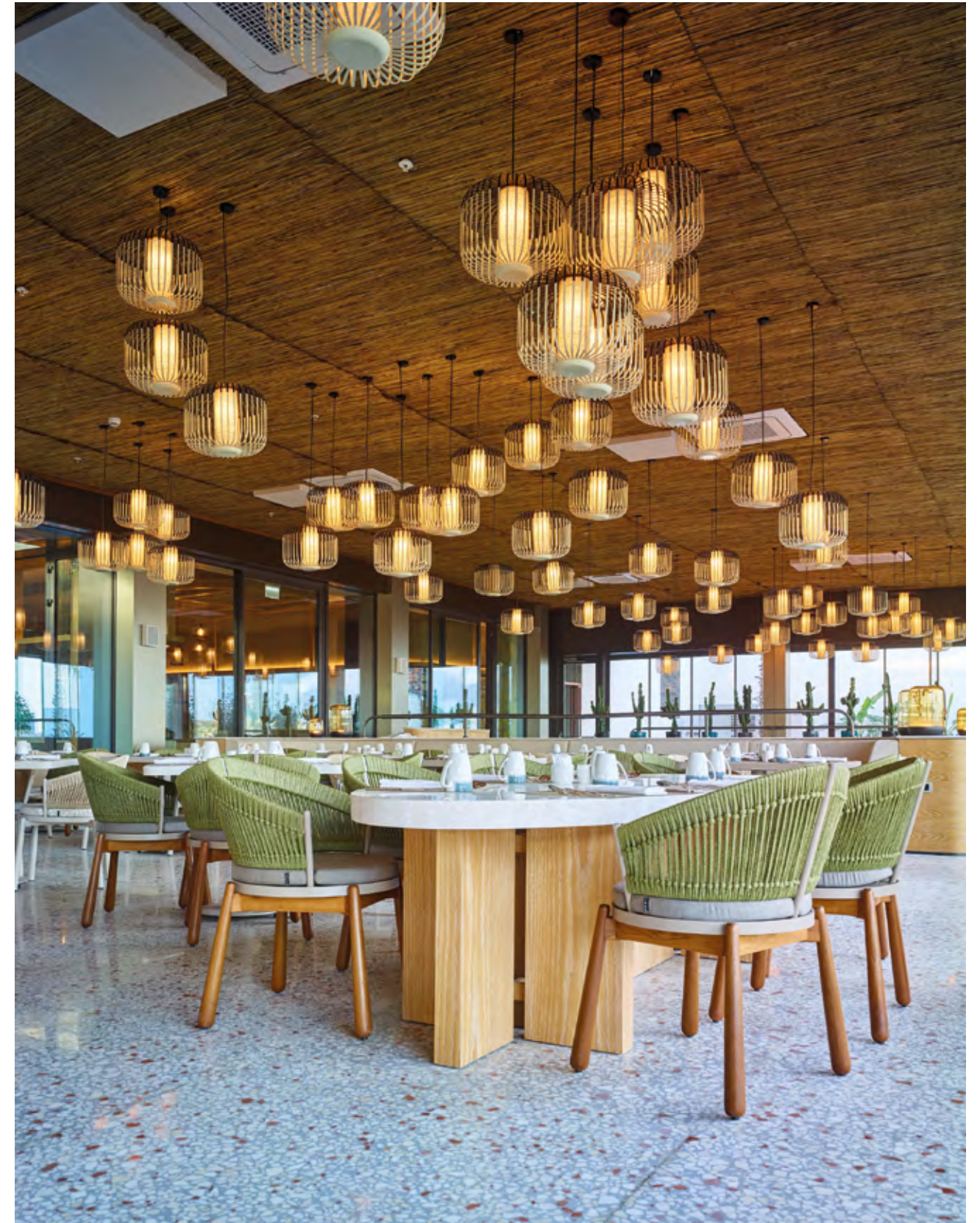





turtle chair

The legs of the TURTLE chairs are available in fine teak wood or aluminum, offering the flexibility to choose the material that best complements the style and atmosphere of the space where they will be placed.





turtle S chair

In this version, the chair is made entirely of aluminum, making it durable enough to withstand extreme weather conditions.



turtle armchair



The TURTLE collection offers exceptional customization possibilities, with a wide range of material and color combinations that allow for tailored designs to suit diverse tastes and settings. From the natural warmth of teak to the versatility of aluminum and the vibrant appeal of ropes, each element invites creative expression.





turtle rocking chair



In the rocking version, the TURTLE armchair transforms into a nest of peace and intimacy. The gentle rocking motion, combined with its wide seat, creates a beautiful sense of comfort.



With its generous dimensions and gently rounded contours, the TURTLE daybed is designed to invite relaxation whether indulging in quiet solitude, enjoying a captivating read, or sharing conversation with company. The backrests are thoughtfully crafted, offering options in sleek aluminum or an elegant combination of aluminum and intricately woven rope, blending comfort with refined aesthetics.



turtle bar stool



turtle coffee table

Sturdy yet lightweight, the TURTLE coffee table is ideal for furnishing any contract outdoor space. It is available in two sizes and is made entirely of aluminum, with an additional version featuring aluminum legs and an HPL top.



UZ collection

angelettiruzza design

Natural elegance
and
contemporary design.





The UZ collection fits naturally into any environment. Balanced, beautiful, and rich in personality, UZ is a furniture collection that thrives both indoors and outdoors, thanks to the richness of the materials used and the timeless quality of its design. Inspired by the geometric shape of the cylinder, which has been cleverly interpreted and adapted in height and diameter to meet the functional and structural needs of the collection, each piece exudes a dynamic and powerful presence. At the same time, it maintains an elegant, modern aesthetic that can easily integrate into any context.

uz armchair

With a strong visual impact, the UZ collection is a line of furniture with a classic soul, evoking the exotic and captivating atmospheres of past travels to distant worlds.





uz sofa

Seats and backs are complemented by soft, removable cushions that enhance the overall feeling of comfort and relaxation, reflecting the company's philosophy of outdoor living.







uz lounge

UZ is made from fine teak wood sourced from Myanmar, where the optimal ecological conditions support the cultivation of these exotic and valuable trees. Known for their dimensional stability, hardness, and water resistance, they are highly durable and can withstand temperature variations, humidity, salt, and weathering.



uz club chair

Extremely comfortable and compact, the UZ club chair integrates seamlessly into any space, while maintaining the high standards of quality that characterize YAAZ's production.





uz chair

The clean lines of the UZ collection define a timeless, balanced, and simple form, while adding a touch of personality to any environment.







uz foldable table



Simple yet ingenious, the UZ table exemplifies thoughtful design. Its teak legs can be easily folded down via a clever rotational mechanism, allowing the support structure to nest neatly within the table. Available in various sizes and shapes, it offers versatility for different spaces while ensuring effortless transportation, space efficiency during shipping, and convenient storage during the off-season.





uz bar stool & counter





uz sunbed

With the UZ sun lounger, every moment of relaxation in the open air is enhanced by functional and refined design, combining the sensory and material qualities of teak with an intelligent space-organizing solution for total comfort. The sun lounger features an adjustable backrest that, when raised, reveals a storage rim for towels, clothes, and personal items.



uz daybed

The clean, softly contoured shapes are complemented by a removable cushion, with internal padding made of Foam Dry. The purity of a timeless, elegant, and refined design is balanced with the practicality and durability required of an outdoor furnishing accessory.



uz double sunbed

Offering irresistible comfort, the UZ double sunbed accommodates two people and ensures maximum well-being. The adjustable backrest, when raised, creates a space with a storage rim for towels, clothes, and personal items.

DENK collection

angelettiruzza design

Design that
evokes
tranquility.

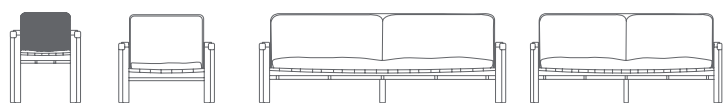

Made from precious teak wood, the DENK seating line features generous volumes and large dimensions, including a chair, armchair, and sofa.





denk sofa

The structure is made of original teak wood, while YAAZ synthetic rope bands are used for outdoor applications. YAAZ rope, a yarn produced by the company, offers excellent protection against the sun and atmospheric elements.



denk armchair

The DENK collection combines elegance and comfort, creating a luxurious outdoor living space. The fine teak wood from Myanmar, paired with the warm tones of the ropes and the finest Sunbrella fabrics, makes this collection ideal for any architectural project or residential setting.



The line includes chairs, armchairs, and sofas in two sizes, all designed to offer ample seating space, perfect for outdoor relaxation. DENK features precise design with timeless allure, where wood, rope, and fabric seamlessly combine style with functionality. It is the perfect blend of classic teak garden furniture with contemporary form.



denk chair

DENK is a collection with pure forms, characterized by an essential and tranquil design that evokes peace and balance. It transforms spaces, fostering warmth and harmony, and creating environments that inspire calm and invite a sense of well-being.



The DENK chair strikes the perfect balance between solidity and comfort, designed to offer a pleasant seating experience for long hours spent around the dinner table with friends, ensuring complete relaxation.



OVA collection

YAAZ lab + angelettiruzza design

A lively
and modular
rhythm.





OVA is a modular seating system with a lively, dynamic character, designed for maximum customization and flexibility. Its aluminum frame is lightweight yet weather-resistant. The backrest design features an interplay of different shapes and heights, which can be adjusted based on the chosen configuration, offering a variety of aesthetic and functional solutions. Comfort is a standout feature of OVA: the deep seat, along with the option to add numerous cushions freely placed on the backrest, ensures each seat is exceptionally comfortable and cozy. This system provides not only a wide range of combinations and configurations but also a relaxation experience tailored to every need, whether in residential or contract settings.



The presence of ropes, available in a wide range of colors and textures, adds a unique aesthetic and material dimension to the collection, enhancing its versatility and contemporary look. OVA's geometries are both simple and original, with clean lines that strike a perfect balance between functionality and innovative design.

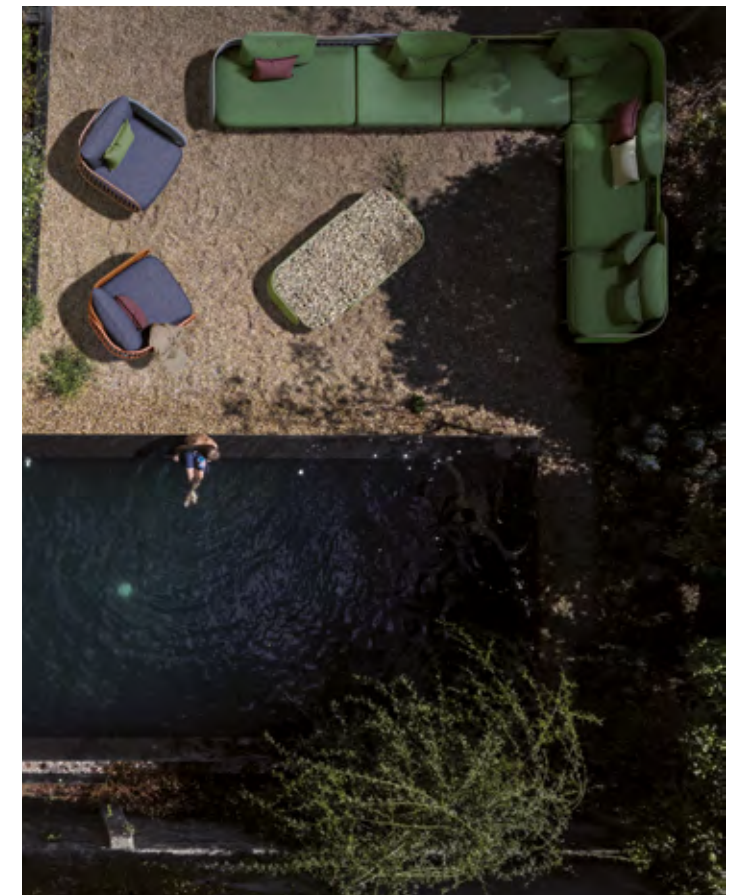



ova modular

YAAZ aims to provide its customers with the opportunity to express their individuality through color choices and tailored materials. OVA embodies this philosophy, offering a high degree of versatility. From the rich material weave created by the ropes to the exclusive YAAZ-designed mesh, or the sleek purity of aluminum, OVA accommodates a range of styles. The available elements can be combined to form an eclectic and original arrangement, or more cohesive choices can be made, depending on personal aesthetic preferences and functional requirements.

- You can find more detailed information about the variations of Ova modular parts on the [Technical info page](#).





ova armchair

The backrest of the OVA armchair is designed to be round and enveloping, resembling two arms coming together in a warm and welcoming embrace. This soft, curved shape not only gives the armchair an elegant and distinctive appearance but also creates a sense of deep comfort, gently enveloping those who sit in it.





EDI collection

angelettiruzza design

Comfortable and
lightweight,
perfect for both
indoor and
outdoor use.





edi chair

The EDI stackable chair is designed for practicality, easily stacking to maximize space when not in use. It can be crafted entirely from aluminum for a modern, minimalist look, or with an original teak backrest, adding a warm, natural touch. This makes the chair perfect for those seeking a balance between contemporary and traditional materials. Light, comfortable, and weather-resistant, the EDI chair is a versatile piece that can furnish any indoor or outdoor space, available in a wide range of colors.

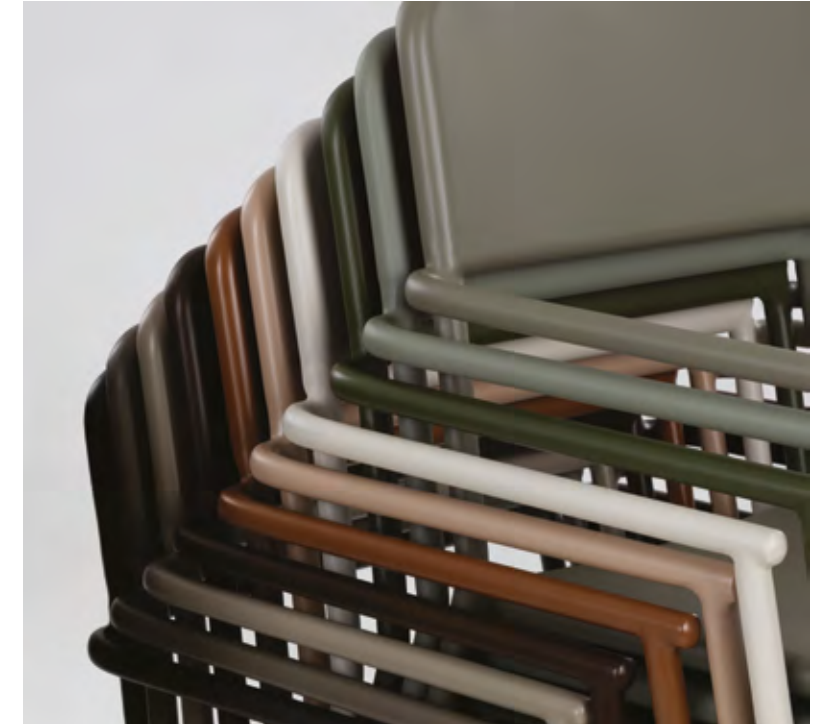

edi stool

Simplicity as an expression of quality: the EDI stool features a pure form, complemented by thoughtful details such as the stainless steel footrest cover. Available in two versions, the stool can be made entirely of aluminum or with a backrest in original teak. Two height options are available: counter and bar stools (H: 85 cm and H: 95 cm).



MONTE collection

angelettiruzza design

Outdoor elegance
and comfort in three
distinctive versions.







monte chair

The MONTE chair is stackable and offers three distinct backrest options. The simplest model is crafted entirely from aluminum, while the more luxurious version features soft cushions that wrap around the backrest, enhancing the outdoor atmosphere for leisurely, relaxed moments. The third version showcases a special rope weave, available in a variety of color variations. The sophisticated metal armrest casting technique further highlights the brand's commitment to detail and its substantial investment in research and development.

SEMT collection

angelettiruzza design

Innovation,
functionality,
and beauty come
together to
enhance the
experience of
conviviality.

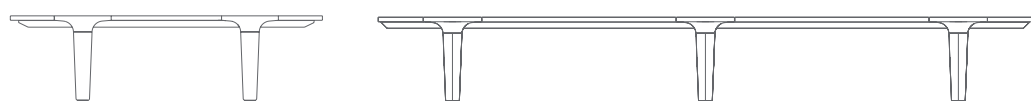



sem table

A modular design for an intelligent table, crafted to meet the demands of a world in search of sustainable and ingenious solutions. The table's supporting structure consists of a single die-cast aluminum module, ensuring stability, lightness, and the elegance of a seamlessly connected shape. By adding modules and extending the teak tops, even larger dimensions can be achieved, making storage, transport, and recycling of the table easier and more efficient.



SAYE collection

angelettiruzza design

Lightness, stability,
and exceptional
functional
performance define
SAYE a timeless
product that stands
the test of time.



saye chair

SAYE is a contemporary reinterpretation of the classic folding director's chair. Comfortable, solid, and functional, its die-cast aluminum frame ensures exceptional outdoor performance, including lightweight construction, resistance to the elements, and remarkable sturdiness. The teak inserts on the armrests add comfort for extended use, while the fabric of the seat and backrest is fully removable for easy cleaning and replacement. YAAZ offers its original take on this iconic, space-saving product.





The functionality of saving space is brilliantly addressed by the foldable design of the SAYE stool, making it easily transportable and storable. The die-cast aluminum structure cleverly designs the opening and closing joint of the seat with remarkable lightness. Thanks to its lightweight and stable characteristics, SAYE is an ideal choice for furnishing any type of boat.

DEDIM collection

michael graves studio

Impactful design
with a
unique character.

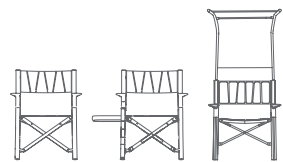



dedim chair with table



The collection is a perfect balance of aesthetics, functionality, and well-being: made of die-cast aluminum and Serge Ferrari technical fabric, it interprets a new way of outdoor living with its strong and original identity. The accessories, reflecting the DNA of the Michael Graves Design Studio, further define the unique character of the chair, which combines aesthetics and functionality in a practical and visually striking object.





dedim chair

DEDIM is characterized by a combination of different geometries with a triangular section, resulting in a comfortable, perfectly connected armrest. Due to its unique construction, it is available in both two-tone and monochrome options.





dedim chair with canopy

The DEDIM chair with canopy immediately invites relaxation, transporting us to a holiday atmosphere even in everyday settings. The canopy adds an element of comfort and protection, transforming the chair into the perfect refuge for enjoying quiet moments outdoors, whether in the sun or during a break in the backyard. The combination of essential design and functionality makes it ideal for outdoor spaces like terraces, gardens, or balconies, as well as for indoor settings that aim to evoke a sense of vacation and freedom. The DEDIM chair with canopy is also an excellent choice for both outdoor and indoor contract spaces, thanks to its originality, sturdiness, and distinctive design.



ANKA collection

YAAZ Lab

Comfort in
contact with
nature.

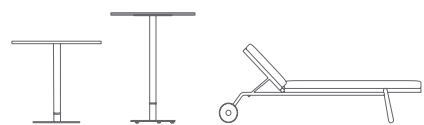

anka sunbed

ANKA is a practical and functional crib designed for both ease of movement and durability. Featuring large rear wheels, it can be effortlessly relocated, making it highly versatile for various spaces. Crafted from aluminum, known for its excellent strength-to-weight ratio and resistance to corrosion, ANKA ensures long-lasting performance in outdoor environments. The frame is coated with electrostatic polyester powder coating, which is highly resistant to water, further enhancing its durability. Available in a wide range of colors, ANKA offers customization options to suit different styles and preferences.

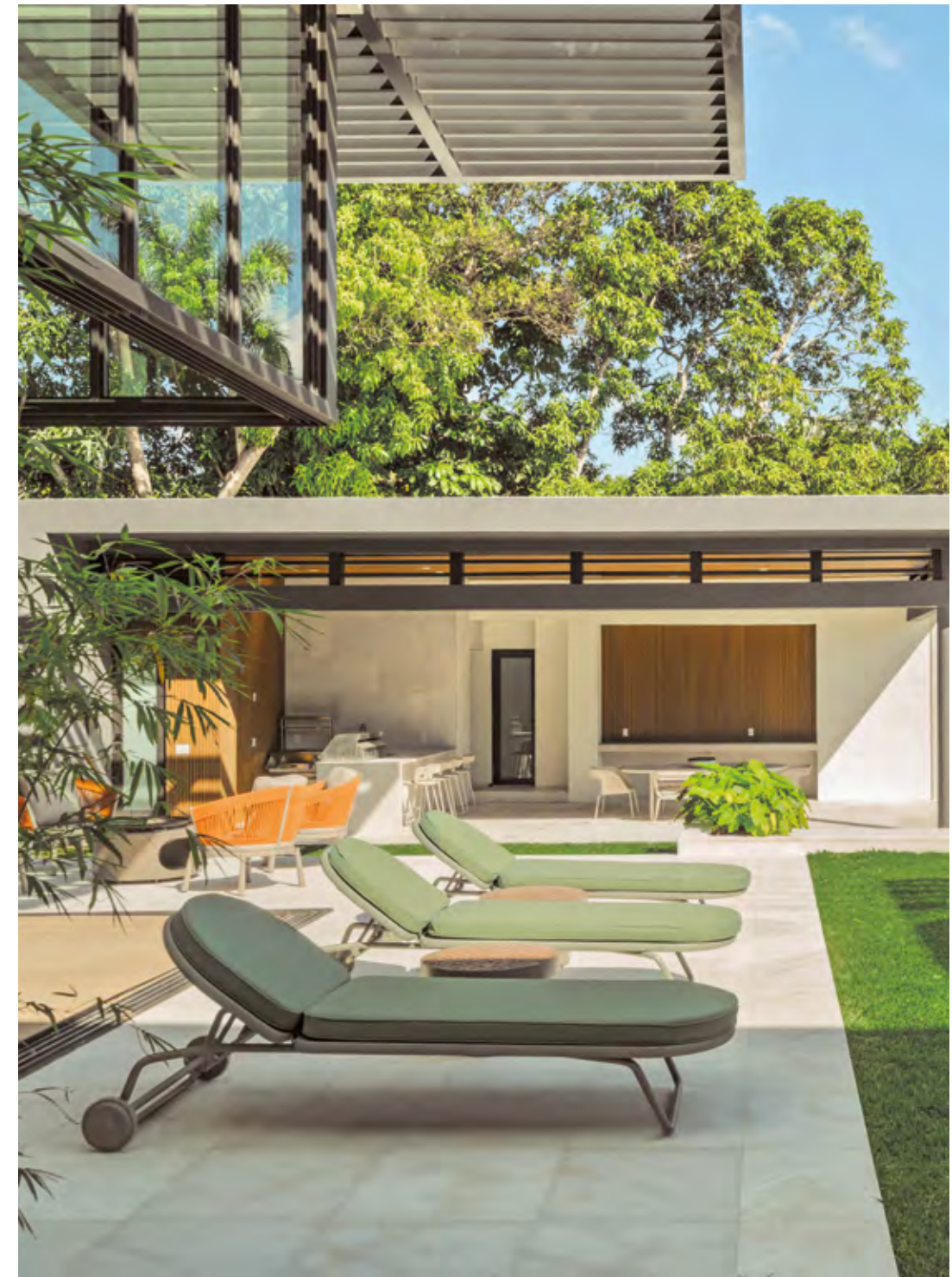



anka table series

The 3-piece table leg offers versatile customization with different color combinations to suit various design preferences. The part resting on the base is made from heavy-duty, weather-resistant stainless steel, ensuring durability and long-lasting performance. The table top can be selected from a range of materials, including aluminum, Z-Pact, and Paviment, allowing for tailored aesthetic and functional choices. The base comes in two size options, $\varnothing 42$ cm and $\varnothing 62$ cm, providing flexibility for different table configurations and space requirements.



ADA
angelettiruzza design

An oasis
of comfort that
redefines indoor
and outdoor life.



ADA is a sofa with generous shapes that can be used from all angles. Like an island in the open sea, it offers different perspectives and invites new, relaxed ways of use. It is an oasis, a flying carpet, a platform to be experienced based on the feeling of the moment—whether you want to rest, play with your children, work, isolate, or share. It is composed of a softer section, a nest of plush cushions where you can feel pampered, and a firmer section where you can eat, meditate, work, or sunbathe. Its soft forms highlight the tactile and expressive qualities of the beautiful fabrics in the catalog, made according to the highest standards of resistance to outdoor elements. ADA is a unique and original piece that fits seamlessly with character into any type of architectural space, both outdoor and indoor.





The feeling of suspension and freedom experienced in the middle of the sea, on a boat, or on a small island, inspired designers Silvana Angeletti and Daniele Ruzza in the creation of ADA. The concept behind this project is to capture the sense of abandonment and serenity that arises when you let go, where only the warmth of the sun, the sound of the water, and the breeze caressing your skin seem to exist.



FESS collection

angelettiruzza design

The heart of
every
outdoor space.

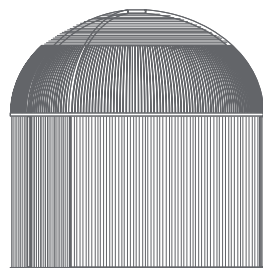



The FESS gazebo has a diameter and height of 3.5 meters. Its spacious and cozy interior features either a rope or teak floor and is fully customizable to the customer's discretion, allowing the creation of a tailor-made environment for any need. You can choose to furnish the space with tables and chairs, ideal for an intimate and exclusive outdoor dining area; armchairs and sofas to transform the gazebo into a relaxation and socializing corner; or sun loungers to rest in the shade, making the gazebo perfect as a wellness area as well.

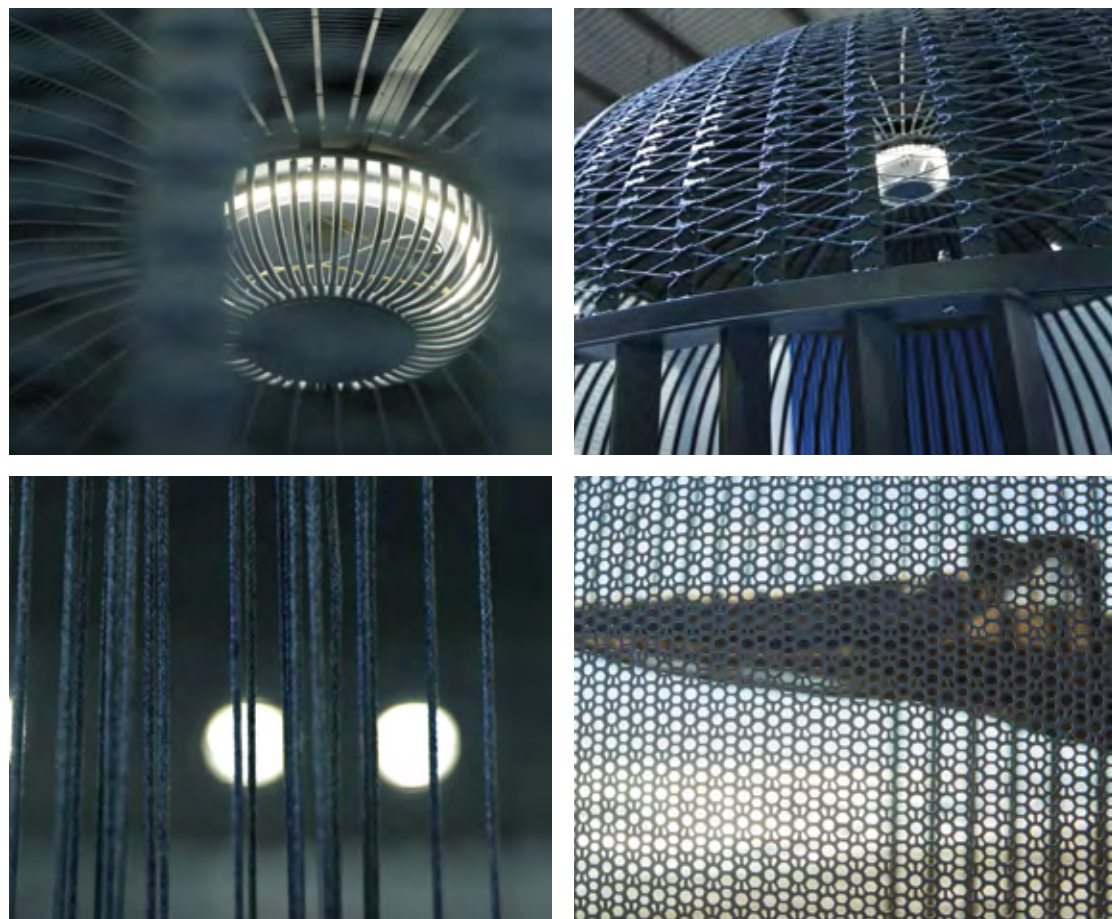

fess cabana

Inspired by the elegant form of the weeping willow, FESS reinterprets the traditional berceau (a richly decorated garden gazebo), offering a contemporary take that preserves the warmth and beauty of these historic spaces, while embracing a modern, minimalist design. A distinctive feature of FESS is its dome, covered with woven ropes that descend to create a pleasant shade, adding a unique textural and decorative effect. These ropes enhance the natural, cozy atmosphere, transforming the gazebo into an ideal retreat for the hottest hours of the day or a secluded corner for an intimate outdoor dinner. The structure is made of aluminum, which can be disassembled, and is equipped with a central light point for a lamp and a fan.

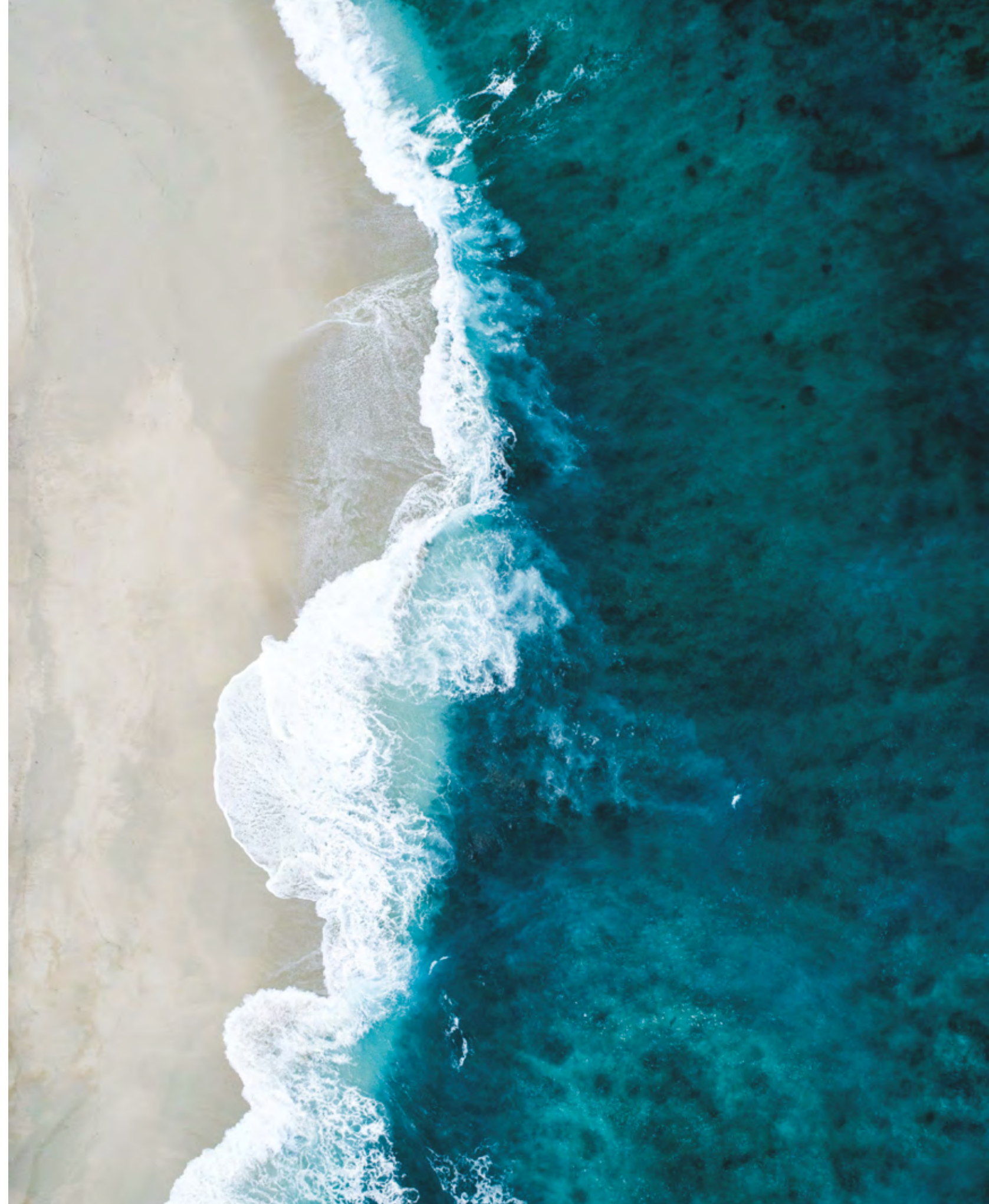

RASEL collection

angelettiruzza design

A modular sofa
designed for
sharing and fostering
strong connections
between people.





rasel sofa

The sofa is made up of three distinct upholstered modules, allowing for a variety of configurations and combinations. It is customizable to suit different comfort preferences and can also be used indoors, offering versatility for both indoor and outdoor spaces.



HAYAL

angelettiruzza design

The encounter
between
Turkish tradition
and
Italian culture.





This poetic piece of furniture, which evokes memories of childhood, was born from the idea of creating a place-non-place, a magical object like a flying carpet that helps immerse oneself in a dreamy dimension. The result of the successful encounter between Turkish craftsmanship tradition and Italian design, the HAYAL circular swings have a strong scenic personality while being defined by a minimalist shape. The frame is made of aluminum, and the seat is covered with a soft cushion, with small tassels embellishing its strings.

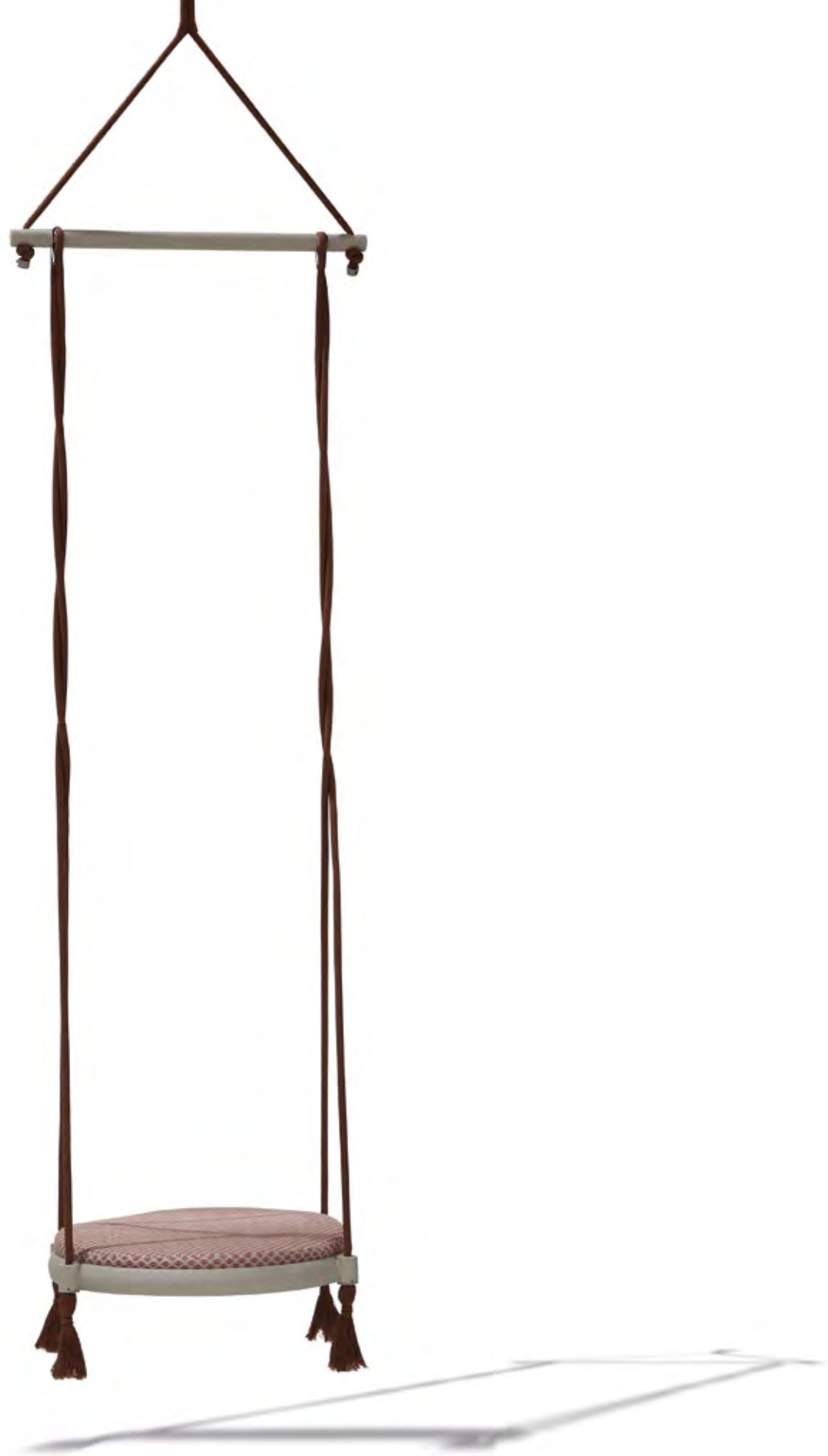

hayal swing

HAYAL is made of aluminum and synthetic rope designed specifically for outdoor use. This yarn, produced by the company, offers high protection from sunlight and weather, ensuring strength and durability over time. Sunbrella fabrics, made from acrylic outdoor fibers, complement the design with excellent resistance to weather, UV, and mildew, maintaining vibrant colors and the integrity of the material even in harsh conditions.



HISS

angelettiruzza design

A vital contrast
that creates
harmony.

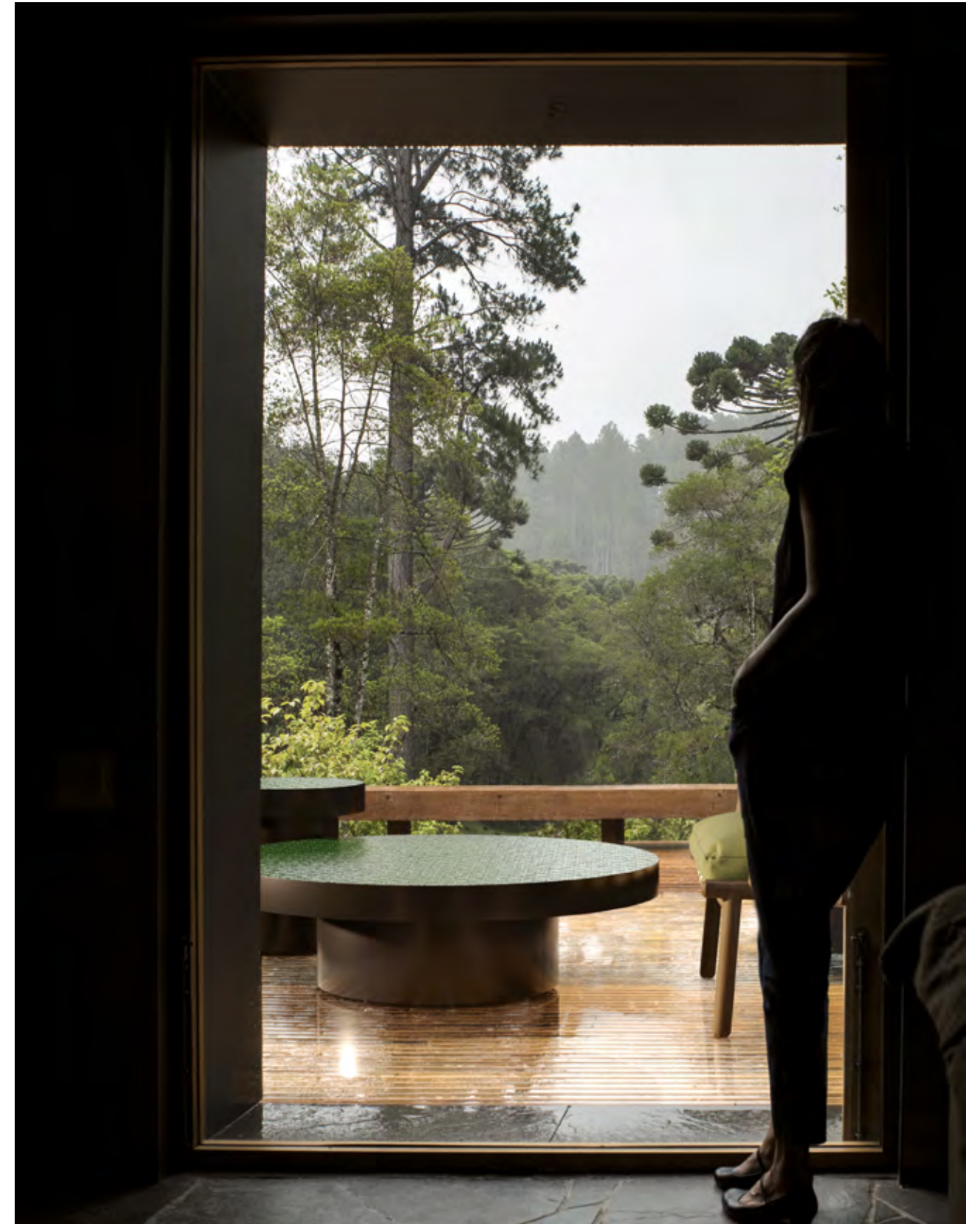
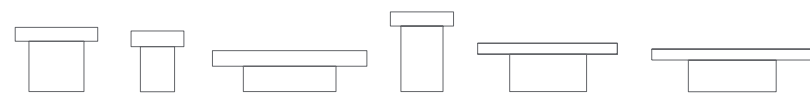



hiss coffee table

The clean lines of aluminum blend with the vibrant imperfection of handcrafted porcelain, creating a fascinating contrast between industrial material and traditional craftsmanship.



This coffee table collection is characterized by various dimensions, designed to enrich any lounge area, both indoors and outdoors. The combination of porcelain and aluminum colors allows for the creation of elegant and refined environments, seamlessly adapting to any space or style.

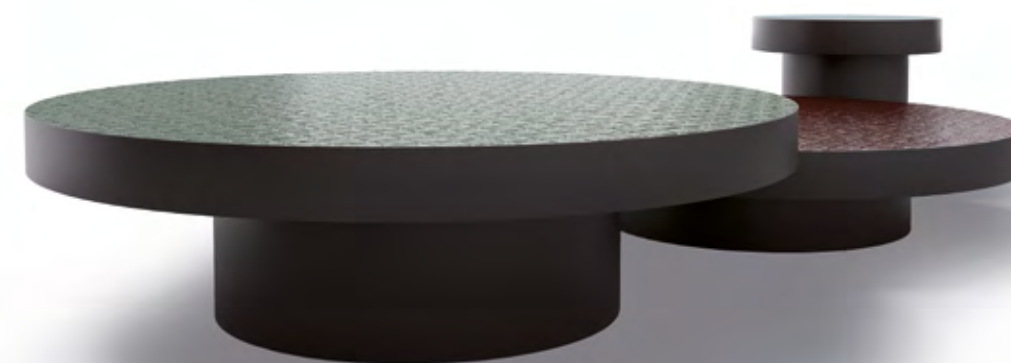
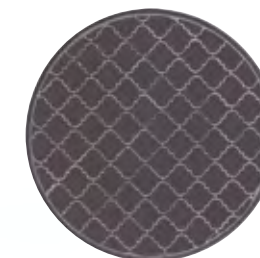
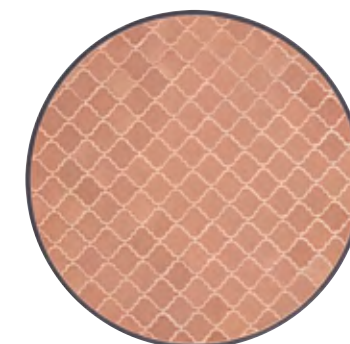
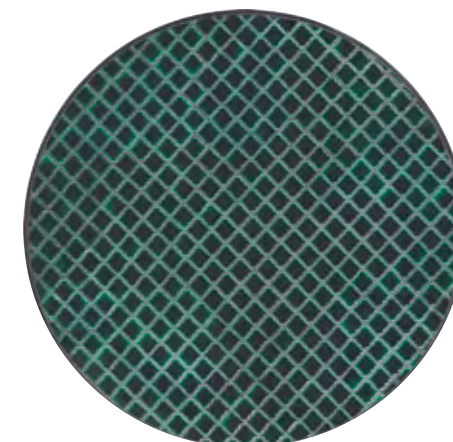

SINI

angelettiruzza design

The small,
colorful flowers
of the net meet
the transparency
of glass
and
the warmth of wood.

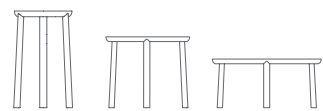



Also ideal for contract use, the SINI coffee table is available in three different sizes:
Ø45 / 17.7", Ø75 / 29.5", Ø100 / 39.4".
The structure of the coffee table is made of natural teak wood, and the table top features a colored wire mesh, based on an original design by our art directors, placed between two pieces of glass.



HARR

YAAZ Lab

The warmth
and
ambiance of
an open fire.

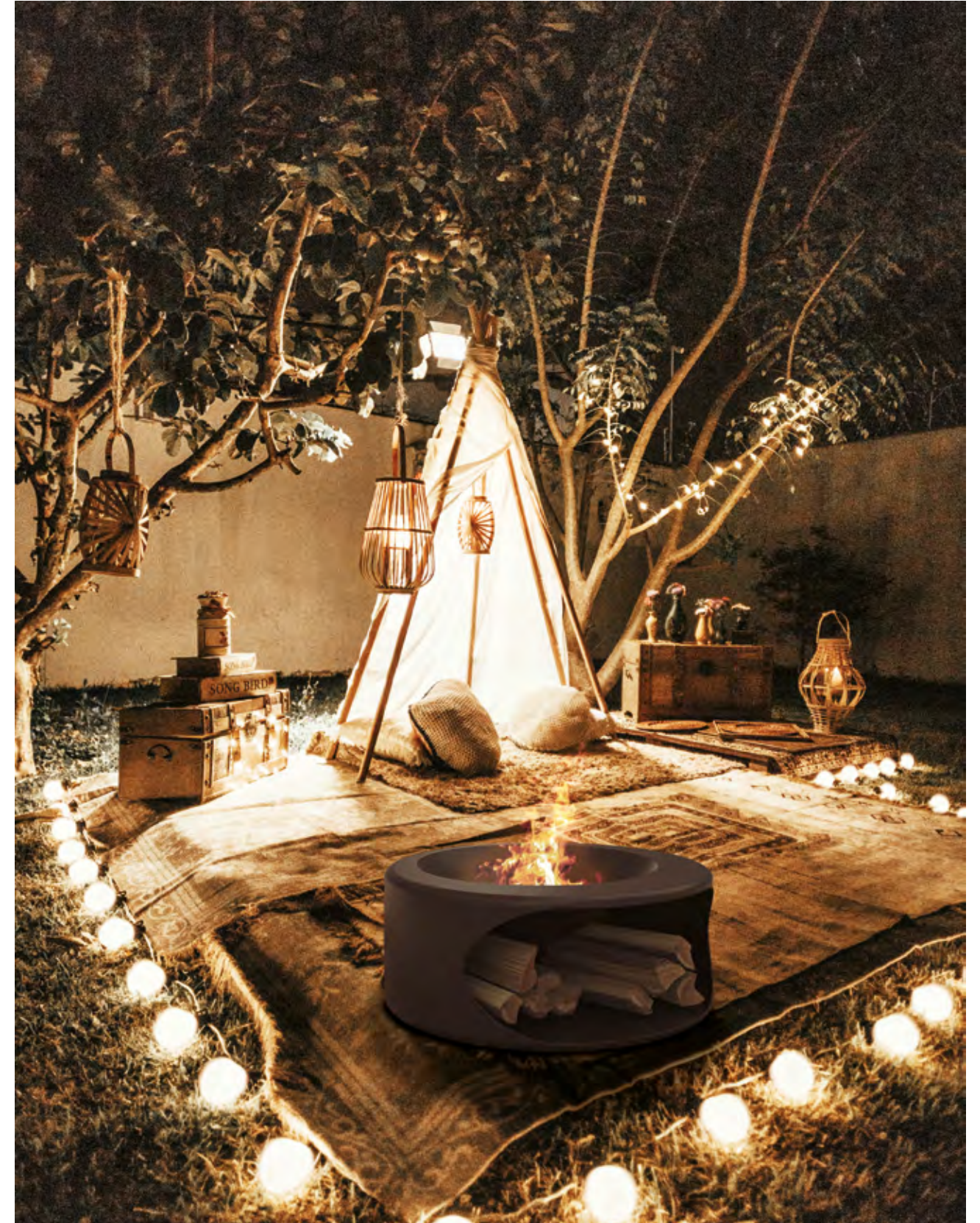
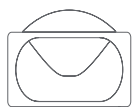



harr fire pit

HARR is a garden fireplace with a dome, crafted from stainless steel. The grill cover can be made from either stainless steel or decorative high-pressure laminate (HPL). Its circular shape enhances the primal charm of fire, providing warmth for both the body and soul.

and coffee table

A top made of either Ment or Z-Pact is also available, transforming the brazier into a comfortable tabletop.

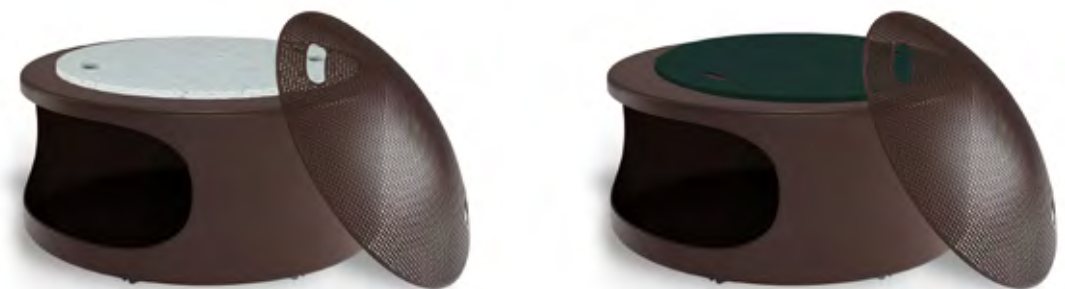

YUNN

angelettiruzza design

Outdoor carpets,
bringing elegance
everywhere.

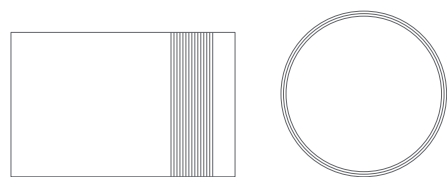

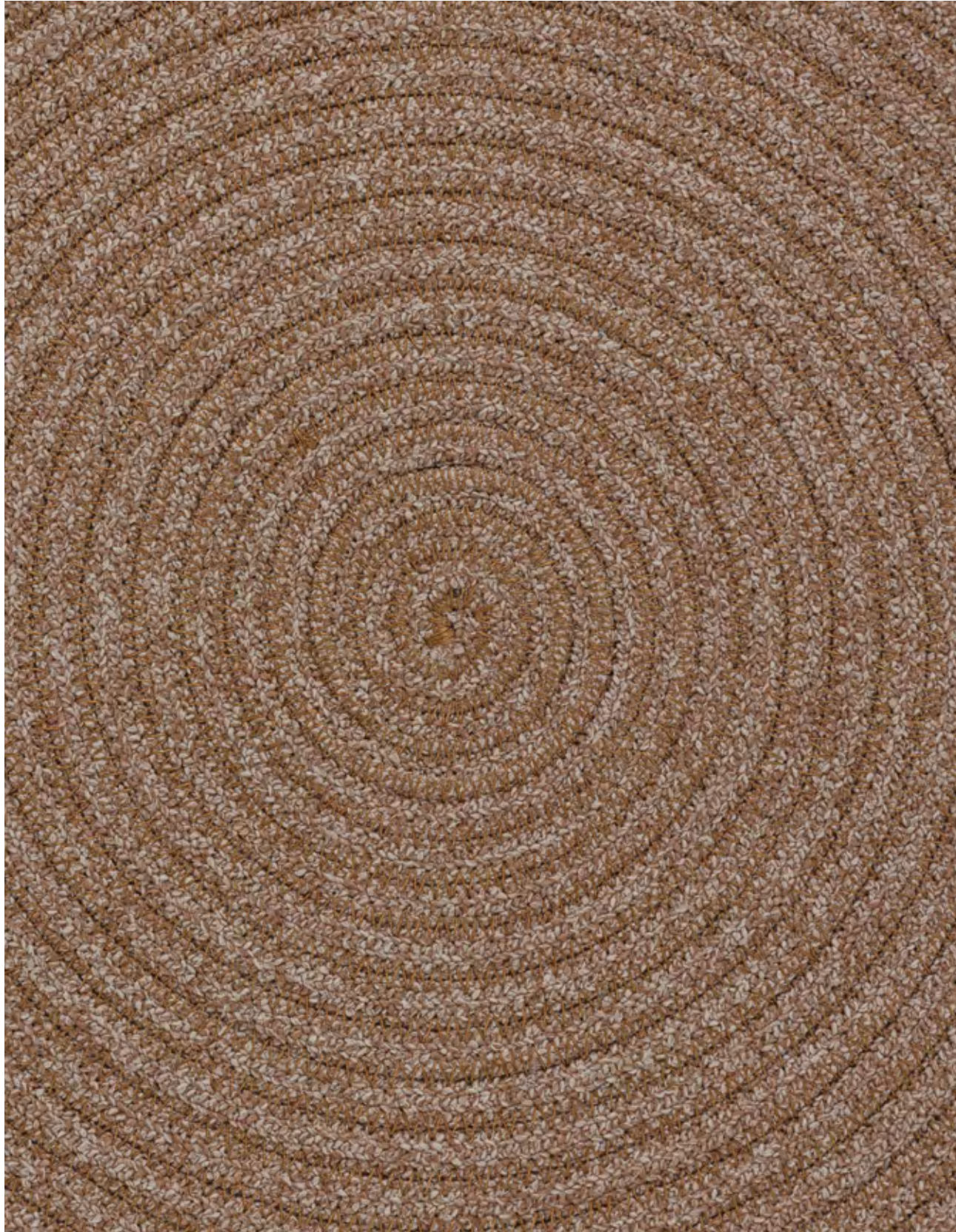

YAAZ Rope, which forms the structure of YUNN carpets, is a sustainably produced material that does not use water in its production. It is available in six different sizes and five different models, and provides thermal insulation thanks to its low heat transfer. In addition, its low coefficient of friction makes the carpet resistant to abrasion. With its hydrophobic structure, it absorbs little water and is resistant to moisture. Its high antibacterial properties help prevent the formation of unpleasant odors. It does not cause skin irritation or allergies, making YUNN both a safe and comfortable option.



The material
expressiveness
of natural
and coloured
terracotta.



The pure shape of the vases, available in four different colors and three sizes, enhances the sensory and tactile qualities of terracotta, an ancient material with timeless appeal.

- *Please look at the technical pages*



MANLE

angelettiruzza design

The lighting that
weaves together stories
of women,
craftsmanship,
and tradition.



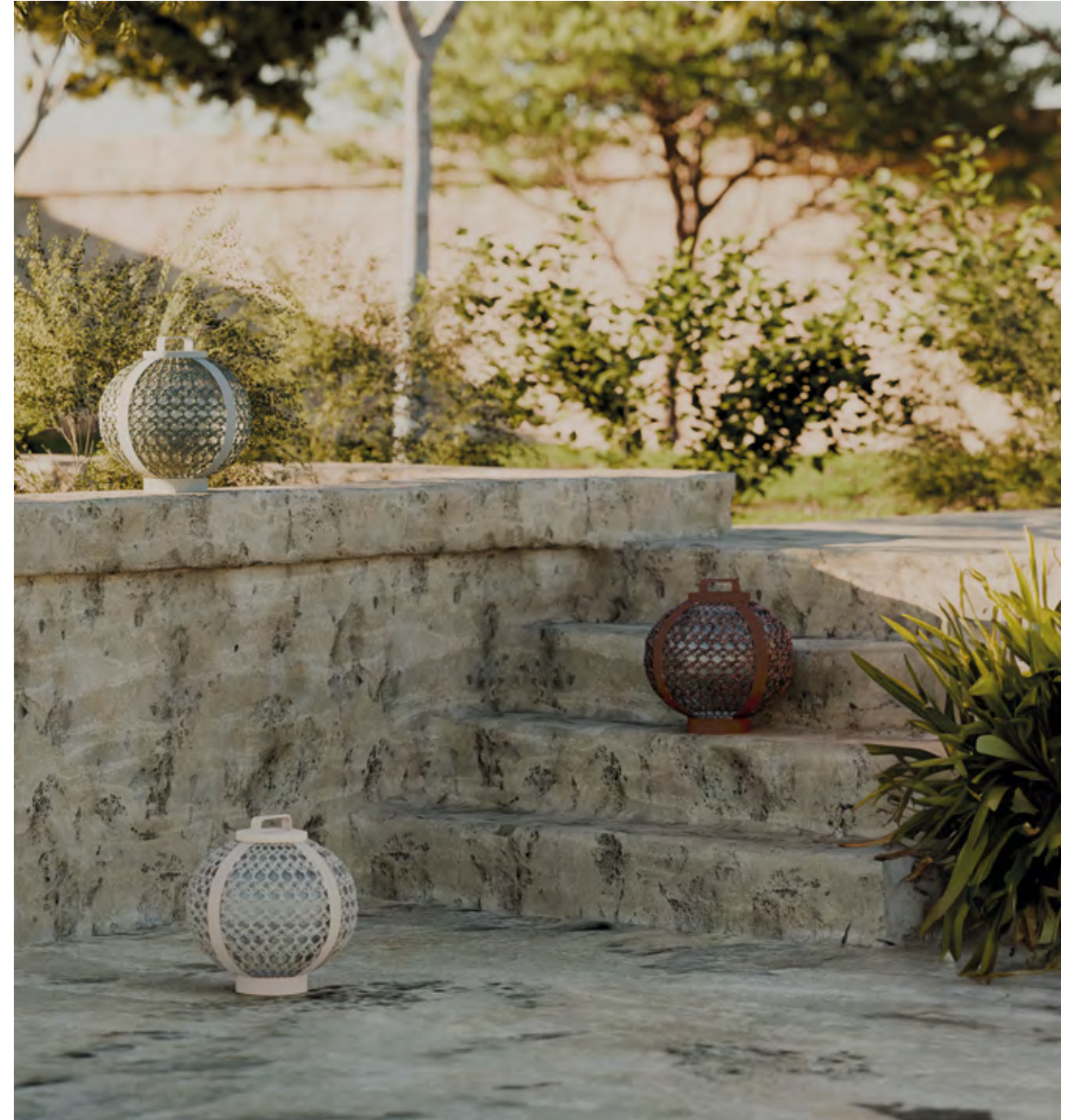

Inspired by the lanterns of the past, MANLE lamps diffuse a soft light that emanates through the meticulously hand-knitted links. The weave takes shape in the skilled hands of women who delicately decorate each object with elegant chain stitches, recalling the magnificent craftsmanship of the past. These sequences of knots encapsulate the stories of the craftswomen who created them.

SWEET

@violanellaiuola

A pillow
that transforms
into a blanket.

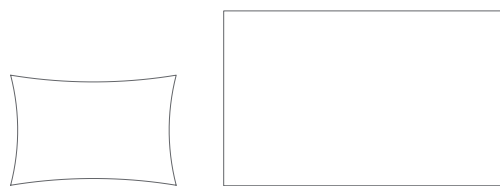



decorative pillow in flow oak
(full color version)

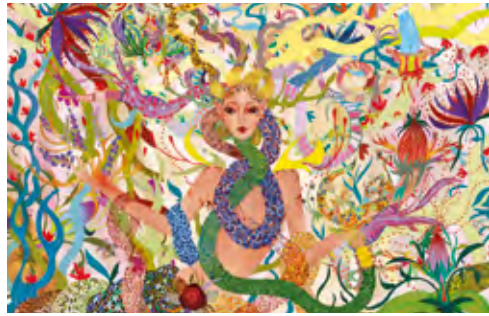

full color version



full color version with a cover flow oak



black version



black version with a cover flow pumpkin



decorative pillow in flow pumpkin
(black version)



decorative pillow in heritage char
(gold version)



gold version



gold version with a cover heritage char



red version

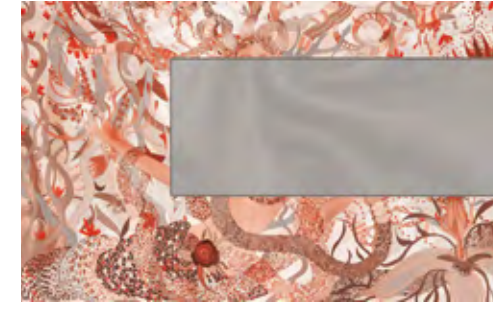

red version with a cover flow sahara



decorative pillow in flow sahara
(red version)



decorative pillow in flow fusion
(blue version)



blue version



blue version with a cover flow fusion

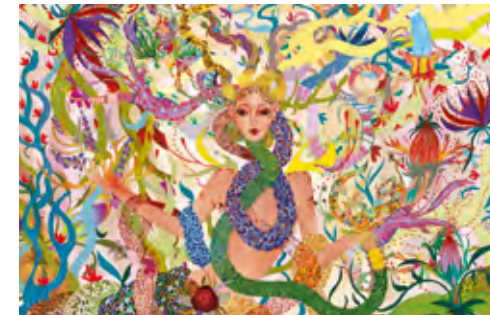

full cover version



full color version with a cover printed with a SWEET
design



decorative pillow in printed outside
(full color version)

Designed by @violanellaiuola, a young Italian fashion designer, these pieces are a fusion of beauty and functionality—a true work of art that captivates with its explosive creativity.

sweet cushion/blanket

SWEET is available in a variety of colors and materials. The cushion is made from five Sunbrella fabrics in the catalog, with each outer color matched to a particular shade of the blanket. One of the six versions features printed fabric with the Sweet design on the outside, perfect for those seeking an accessory with a unique character. SWEET furnishing accessories are more than just a cushion and blanket combined. They represent a fantasy world, where female creatures live in harmony with nature, free from separation, celebrating a fluid and balanced understanding.

Seeking
beauty
in
simplicity.



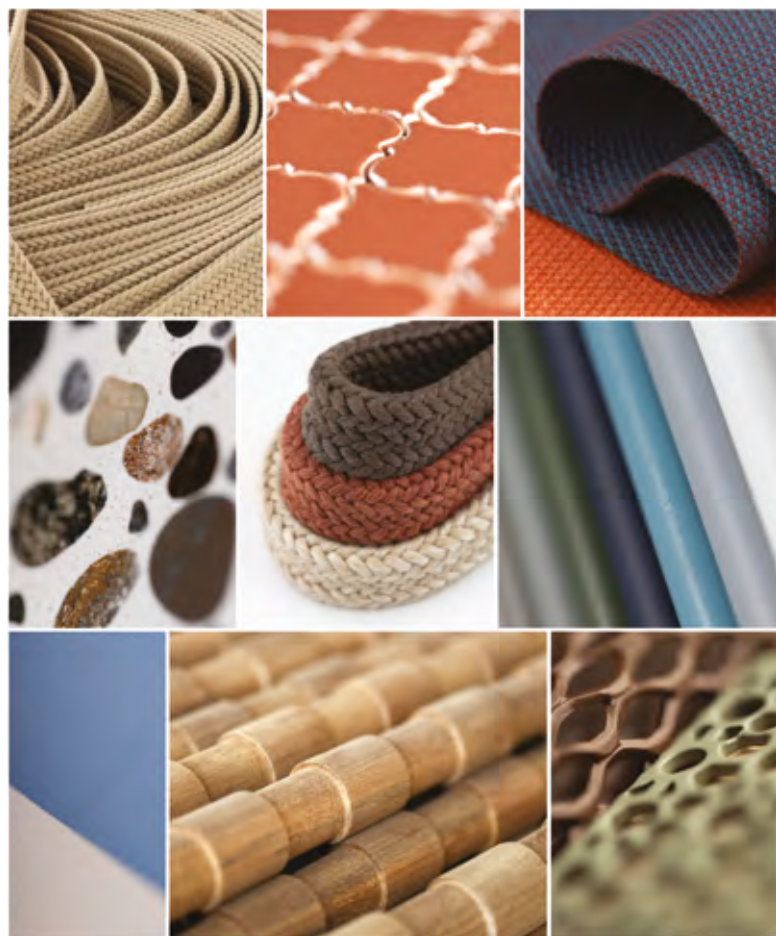

Quality is important in every environment, but in outdoor spaces, it becomes a fundamental reason for standing out in the market. This is why we use the best raw materials, as we believe it is both an ethical and sustainable choice. From this foundation, we have begun to build, selecting carefully calibrated finishes and color shades that focus on beauty—on the feelings of serenity that define a design approach in search of harmony. We draw inspiration from the colors of nature, which relax and nurture the need for silence and light, serving as an endless source of wellness and rootedness.

finishes & mood- boards

black and white emotions



Aluminium

Aluminium is a light and strong metal with excellent strength-to-weight ratio and corrosion resistance. These properties make it an ideal material for outdoor furniture. Despite its light weight, aluminium is durable and is coated with polyester electrostatic powder coating for added protection against knocks and scratches and to add colour to the product. As the powder coating adheres better to the metal, it also makes the product much more resistant to fading. JOTUN and Akzo Nobel branded powder coatings are used in YAAZ aluminium products.

JOTUN powder coatings used in YAAZ products have been tested against high amounts of UV radiation and strong winds. In addition, powder coatings have been tested in some of the hottest, most humid and corrosive environments in the world, such as Southeast Asia and the Middle East.

In YAAZ aluminium products, 7001 series aluminium, which is especially preferred in the defence industry, is used. With its high hardness ratio, it is extremely resistant to all weather conditions (-50 / +50) and the effects of sand, dust and sea salt.

As with other metals, aluminium can heat up or cool down depending on weather conditions, so it is recommended to use with a cushion for comfort.

Standard Composition: EN 573-3

Standard Properties: EN 755-2

Cleaning and Handling Instructions

For regular cleaning, wipe aluminium furniture with a soft cloth or sponge and a mild detergent solution. Avoid using steel wool or abrasive cleaners as they may scratch the aluminium surface. Rinse the furniture thoroughly with clean water and dry with a clean, dry cloth. To avoid damages such as dents and scratches on the surface of the product, use aluminium polish.



a warm colour life



YAAZ Rope

We have created a vibrant collection using our YAAZ ROPES. YAAZ ropes are produced from raw materials with OEKO-TEX, SGS and UKAS International quality certificates, with proven strength, high resistance to all weather conditions and UV colour fastness. Our design team has carefully selected and produced a colour palette that can be easily combined with our aluminium frame colours.

- * Outdoor furniture ropes made of durable acrylic-based raw materials provide superior protection against the sun's harmful rays and harsh weather conditions
- * The UV resistance and color fastness of the used products are regularly tested in accordance with ISO 105-B04 standards.
- * With a wide range of colors, outdoor furniture threads perfectly cater to your design needs.

Cleaning and Using Instructions

Dust the rope furniture regularly with a soft cloth or soft sponge to remove light dirt or debris. For deeper cleaning, gently clean the rope with a solution of white soap and warm water using a soft sponge. Then rinse thoroughly with clean water. Harsh chemicals can damage the rope and cause discoloration. Do not use. After cleaning, allow the furniture to dry completely before using it again.

Avoid placing heavy objects on the furniture and do not put weight on the drawstring parts of the furniture to avoid rope sagging. Avoid dragging or scraping the furniture on hard surfaces as this may damage the rope and frame. Avoid using the furniture in weather conditions such as heavy rain or high winds as this will prolong its life. To prolong the service life of the furniture, store it under protective YAAZ cover when not in use.

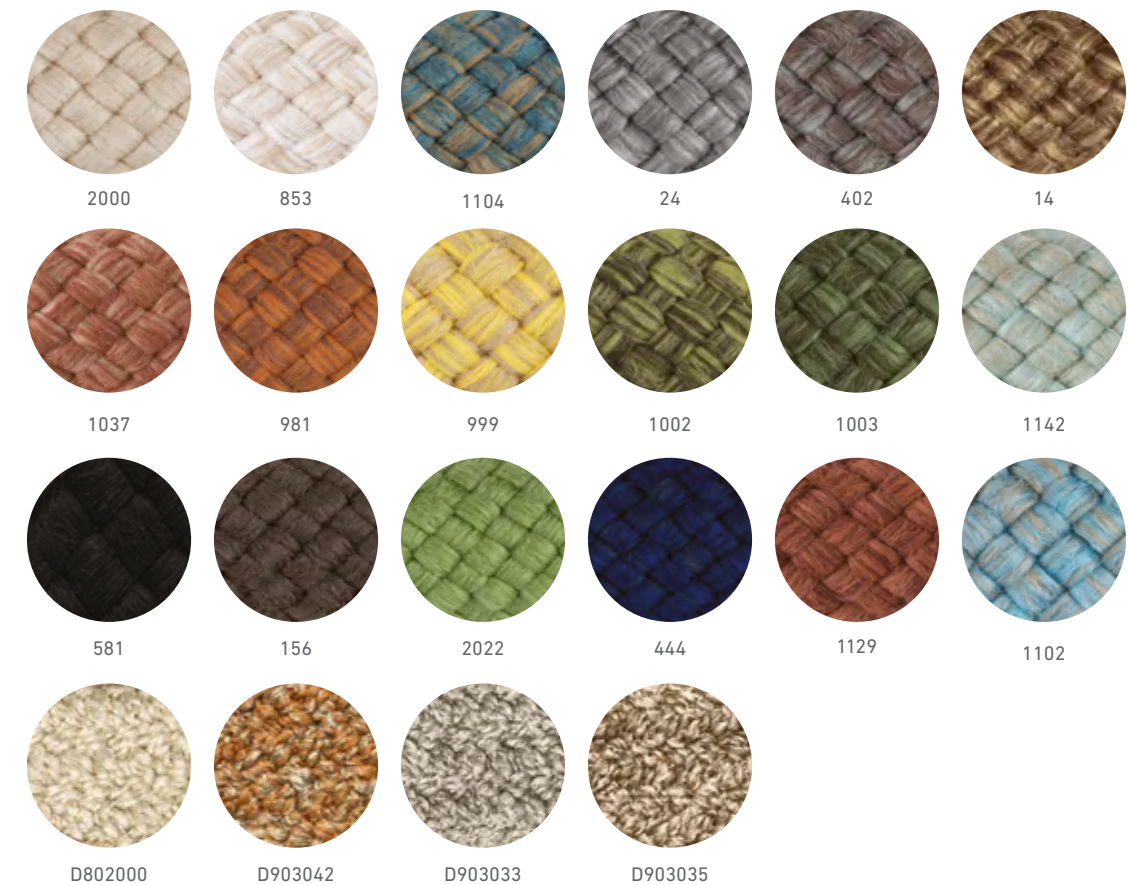

sweetly joyful



Teak

Teak wood is particularly well suited for outdoor use due to its durability, robustness and strength. The natural teak blocks we import from Myanmar are processed in our factory for all stages until they become products.

Cleaning and Using Instructions

General:

Moisture, wind and heat can cause small cracks in the teak material, causing it to collapse. These should be considered the natural behaviour of a "living" material. Their appearance and duration depends on the humidity level in the air. Cracks that can occur when the wood dries quickly tend to close when the humidity level increases. Dark spots or streaks are caused by the moisture contained in the wood. The appearance of teak wood will tend to even out during the first few weeks outdoors. Continuous exposure to atmospheric conditions causes superficial oxidation (1-2 mm) of the wood, which manifests itself in the characteristic silver-grey colour. This does not affect the underlying structure and does not change its resistance to external factors. In the first weeks of outdoor use and with the first rains, the wood may release red pigment due to its natural characteristics or micro-residues from processing; in such a case it is recommended to wash the floor immediately with products suitable for the surface. In very humid conditions, teak wood may release a reddish-coloured oil and stains may appear on the surface. These stains can be treated as follows: For normal cleaning of the wood, use a soft cloth (not microfibre), water and a non-chemical cleaning agent. In case of deep and difficult to remove stains, it is recommended to sand the surface evenly and polish it with a special product for the restoration of outdoor wooden furniture. This type of restoration product should not be used more than once a year. To prevent oxidation of the product surface, it is recommended to apply a nourishing and protective oil to the surface. To remove the grey patina caused by oxidation and restore the original colour of the teak, use a special product for the restoration of outdoor wooden furniture every 2/3 years. After this process, wash the product with a non-chemical detergent and after drying, apply an impregnating agent specially made for outdoor wood. Do not use wire brushes, abrasive products, bleach, acids and aggressive chemical solvents. Do not use pressure cleaners at close range or at high temperatures.

1. For regular cleaning, wipe teak furniture with a soft cloth or sponge and a mild detergent solution.
2. To remove stubborn stains or accumulated dirt, use a teak cleaner or a mixture of vinegar and water. Apply the solution to the furniture with a soft-bristled brush, then rinse thoroughly with clean water.
3. Allow the furniture to dry completely before reuse.
4. To preserve the natural colour of teak wood, apply teak preservative or teak oil once or twice a year. This will help protect the wood from the elements and prevent it from turning grey.

Using the guidelines:

1. Do not place hot objects directly on teak furniture as this can cause heat marks or discolouration.
2. Avoid placing heavy objects on the furniture as this can cause it to warp or crack over time.
3. Do not drag furniture over rough or uneven surfaces as this can scratch or damage the wood.
4. If possible, store the furniture indoors or under the YAAZ protective cover when not in use to prolong its useful life.

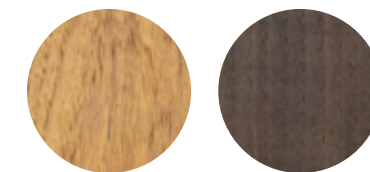

light teak

dark teak

deep breath

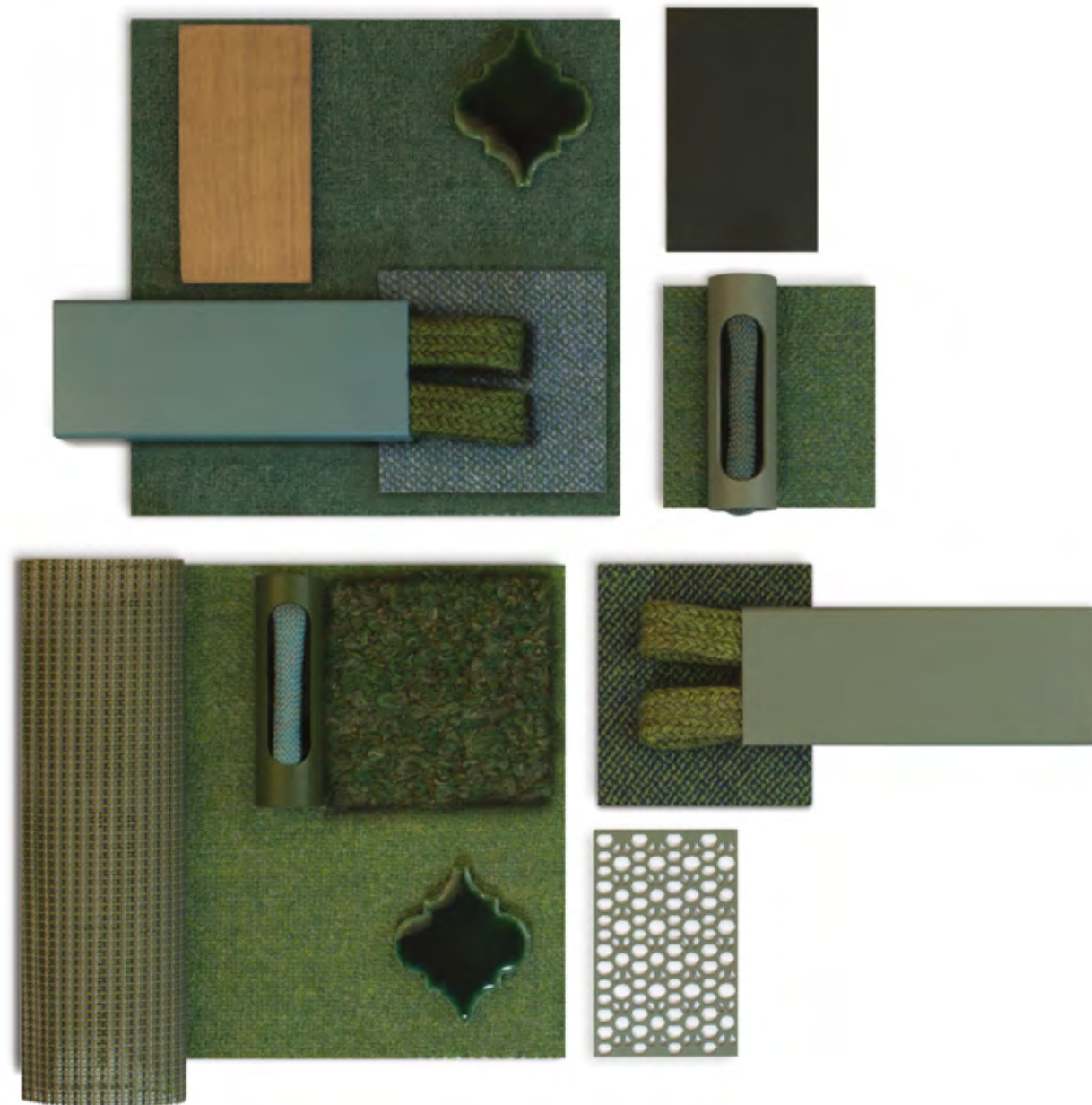

Ment

High-strength terrazzo plates produced with the highest quality natural stones. A first-class appearance is obtained with homogeneous color and aggregate distribution on large surfaces. Ment plates provide wide possibilities for different designs in spaces with the resistance to color fading and unlimited color and a wide variety of dimensions, especially for outdoor use. In terms of sustainability, the water used in Ment production is recycled and recycled again. Precast is made of natural aggregates. It provides heat and energy saving with its long-term thermal heat retention and slow release feature in the areas where it is used. In Yaaz Ment products, epoxy synthetic resin is used as "binder" instead of cement. Therefore, it is not easily stained in daily use.

Cleaning and Using Instructions

For daily cleaning, simply wiping with a clean, damp cloth is sufficient to keep dirt and grit off the surface. When not cleaned regularly, sand and soil residues that can accumulate on outdoor ment products act as abrasives and damage the surface. Use only neutral liquid cleaners (meaning neither acid nor alkaline ones). For best results, use a commercial cleaner made specifically for terrazzo. All-purpose household cleaners, soaps, detergents and wax cleaners usually contain one or more alkali and therefore should not be used on ment.

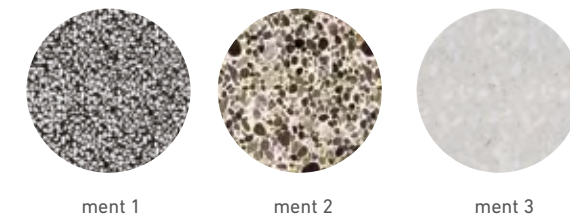

Perforated Sheet

Our perforated sheets made of aluminium are shaped by CNC machines in our factory with patterns specially designed for YAAZ.

Cleaning and Handling Instructions

For regular cleaning, wipe aluminium furniture with a soft cloth or sponge and a mild detergent solution. Avoid using steel wool or abrasive cleaners as they may scratch the aluminium surface. Rinse the furniture thoroughly with clean water and dry with a clean, dry cloth. To avoid damages such as dents and scratches on the surface of the product, use aluminium polish.

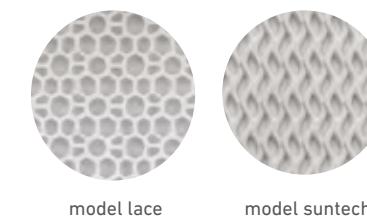

sky and see



Band

The straps we use in the UZ collection are specially designed with YAAZ ROPE raw material and production method. The colours chosen are determined by colour engineers to match the wood and fabric collections.

The straps we use in the Monte collection are flexible straps produced by Sunbrella and are under the assurance of Sunbrella. The selected colours were determined by colour engineers to match the wood and fabric collections.

Cleaning and Using Instructions

Dust the rope furniture regularly with a soft cloth or soft sponge to remove light dirt or debris. For deeper cleaning, gently clean the rope with a solution of white soap and warm water using a soft sponge. Then rinse thoroughly with clean water. Harsh chemicals can damage the rope and cause discolouration. Do not use. After cleaning, allow the furniture to dry completely before using it again.

Avoid placing heavy objects on the furniture and do not put weight on the drawstring parts of the furniture to avoid rope sagging. Avoid dragging or scraping the furniture on hard surfaces as this may damage the rope and frame. Avoid using the furniture in weather conditions such as heavy rain or high winds as this will prolong its life. To prolong the service life of the furniture, store it under protective YAAZ cover when not in use.



colors and fragrances of nature



Porcelain

Porcelain, which is among the ceramic types, gains superiority as the most valuable product of your space thanks to its durability, special compactness and resistance to external factors.

Its integrity with the glaze shows resistance to staining. This material is extremely resistant to chemical-atmospheric substances, and since it is baked at high temperature, it is extremely resistant to frost and temperature with its water repellent feature. It is a long-lasting outdoor material in terms of high resistance to abrasion and staining.

Cleaning and Using Instructions

Since it is a water repellent material, it will not be subject to any staining. It is sufficient to wipe any liquid spilled on the surface with a clean and soft cloth.

Since porcelain products are completely handmade, the slight crack appearance that will occur over time is natural and is not considered a defect.

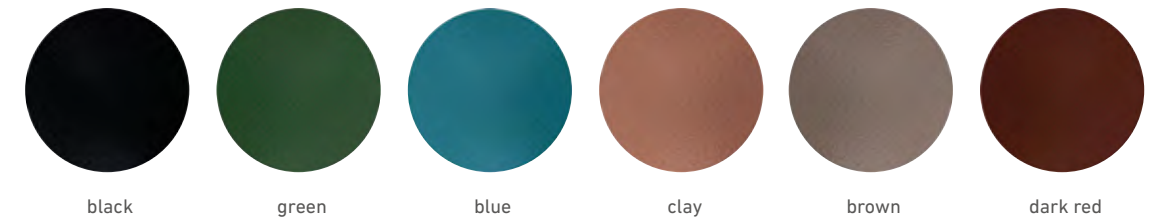

Coating Concrete

The stone effect paint collection, developed with the cement spraying method, offers a great alternative for aesthetic surfaces in outdoor products.

Cleaning and Using Instructions

Over time with exposure to the elements, powder coatings may show signs of weathering such as loss of gloss, chalking and slight colour change. A simple regular clean will minimize the effects of weathering and will remove dirt, grime and other build-up detrimental to all powder coatings.

For any particular region or territory, there may be local regulations or local requirements to be met in order to achieve conformance to certain published quality labels or standards. It is the users' responsibility to be aware of such standards.

Records of all cleaning schedules and frequencies shall be kept and maintained and made available to YAAZ if requested. Failure to comply with the recommended cleaning schedule will nullify any warranties.

Cleaning should start at the time the products are installed, ensuring that construction materials such as concrete, plaster and paint splashes are removed before they have a chance to dry. Failure to remove these materials at this early stage will require the use of aggressive cleaning materials and techniques with potential damage to the powder coated surface.

Coating Concrete products are best cleaned by regularly washing the coating using warm water and a non-abrasive, pH neutral detergent solution. Surfaces should be rinsed thoroughly after cleaning to remove all residue. All surfaces should be cleaned using a soft cloth or sponge or something harder than a soft natural bristle brush.

If the project is subject to any hazardous unusual environmental factors, or is close to salt water, an estuary or marine environments then YAAZ must be consulted on an individual project basis.

Renovation can be required in the case of heavy soiling (due to lack of maintenance). It is then recommended to consult to YAAZ.

Usual maintenance can be done using water with mild detergent (pH 5 to 8). If the atmospheric pollution has resulted in heavy soiling of the coating, some stains or marks may require stronger domestic products. In such cases, they should always be diluted, and small inconspicuous test areas cleaned first. In no circumstance should any abrasive cleaner or polish, or any cleaner containing ketones, esters be used.

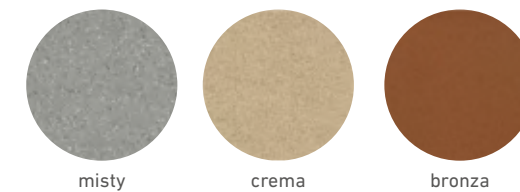

seduction of the desert



fabrics

-  Bleach cleanable
-  Breathable comfort
-  Mold / mildew resistant
-  Water & stain resistant
-  Sun protection
-  UV / fade resistant

Sunbrella Fabrics

Outdoor fabrics made of acrylic fibre are strong. They are more resistant to both weather conditions and handling faults such as mould, scuffing and tearing. This is especially important for outdoor upholstery in active residential and commercial applications. Before weaving, the acrylic fabric yarns are solution dyed. This allows the fabric to retain its colour longer, even when exposed to direct sunlight. In addition to water repellency, acrylic fabrics are more breathable than other options, allowing the fabric to stay cooler in hot weather.

Sunbrella acrylic fabrics are considered premium for outdoor textiles.

Especially in terms of UV protection, Sunbrella is long-lasting compared to its counterparts and therefore offers long-term savings.

Traditional dyeing processes only leave color on the surface of fiber, so they easily fade. Sunbrella fibers are saturated to the core with highly UV-stable pigments, making Sunbrella fabrics resistant to fading and the degrading effects of sunlight.

All Sunbrella fabrics are engineered to resist mold and mildew. Should exposure to dirt and debris cause mold and mildew to occur, all Sunbrella fabrics can be easily and safely cleaned with bleach.

Cleaning and Using Instructions

****Please observe the washing instructions label inside the cushion.**

To facilitate the daily care of your Sunbrella fabric:

Remove loose dirt with a sponge.

Spray with a cleaning solution of water and mild soap.

Allow the cleaning solution to penetrate the fabric.

Rinse thoroughly until all soap residue is removed and air dry.

Do not use bleach or softeners, as these can damage the fabric and affect its water-resistant properties.

If the fabric gets wet, allow it to dry completely before use to prevent mould growth.

You can machine wash the fabric in cold water on a gentle cycle using a mild detergent.

If ironing is necessary, use a low heat setting and a press cloth to avoid direct contact with the fabric.

Protect furniture with the fabric from inclement weather such as rain, snow and extreme temperatures by storing it under YAAZ covers.

CAST

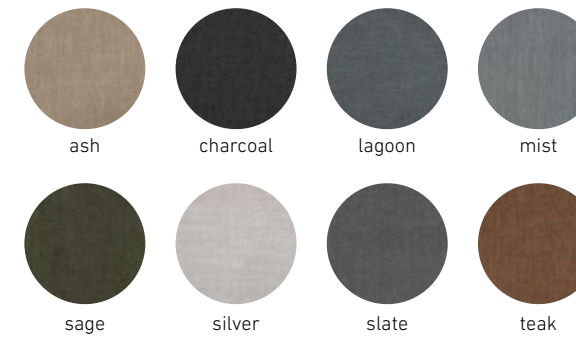

HERITAGE



LINEN



PLAY



YAPA

The YAPA fabric collection, specially produced by yaaz, is strong, durable and easy to maintain. The collection is designed to be in line with the latest trends and displays a contemporary look, softness and comfort to the touch in line with the best indoor fabrics, while offering the strength and durability of outdoor fabrics, thanks to the waterproofing that provides protection against all environmental factors.

Cleaning and Using Instructions

****Please observe the washing instructions label inside the cushion.**

To facilitate the daily care of your YAPA fabric:

Remove loose dirt with a sponge.

Spray with a cleaning solution of water and mild soap.

Allow the cleaning solution to penetrate the fabric.

Rinse thoroughly until all soap residue is removed and air dry.

Do not use bleach or softeners, as these can damage the fabric and affect its water-resistant properties.

If the fabric gets wet, allow it to dry completely before use to prevent mould growth.

You can machine wash the fabric in cold water on a gentle cycle using a mild detergent.

If ironing is necessary, use a low heat setting and a press cloth to avoid direct contact with the fabric.

Protect furniture with the fabric from inclement weather such as rain, snow and extreme temperatures by storing it under YAAZ covers.

LINE

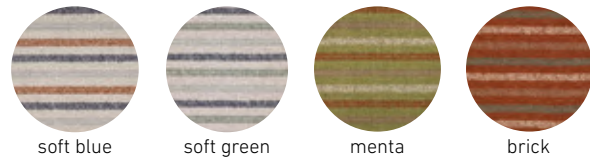

soft blue soft green menta brick

RIA

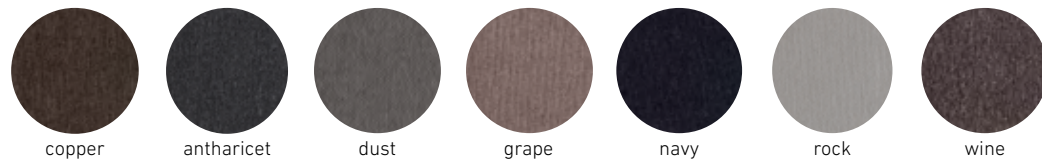

copper antharicet dust grape navy rock wine

AKS

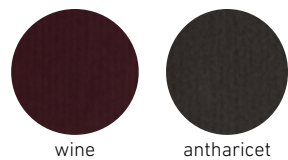

wine antharicet

FLOW



crema milk pumpkin spice sahara rustic oak coffee
 aqua royal stone sand ocean petra fusion blazer
 smoke sapphire latte

VOYAGE

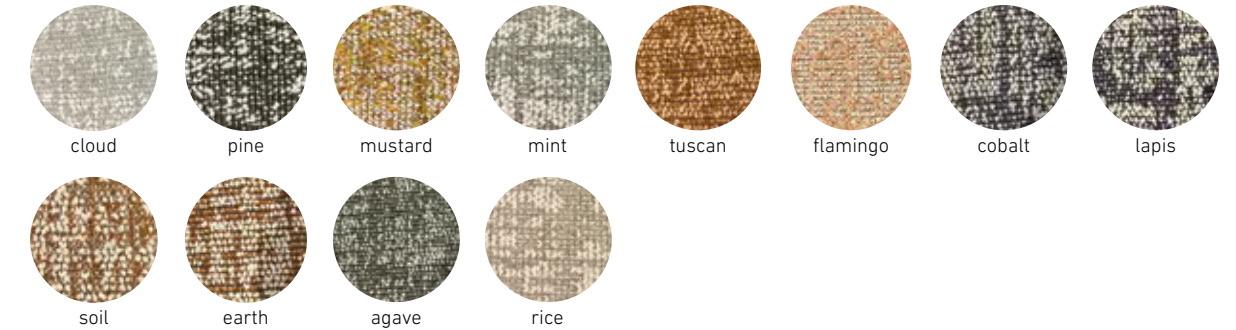

cloud pine mustard mint tuscan flamingo cobalt lapis
 soil earth agave rice

ASTEC

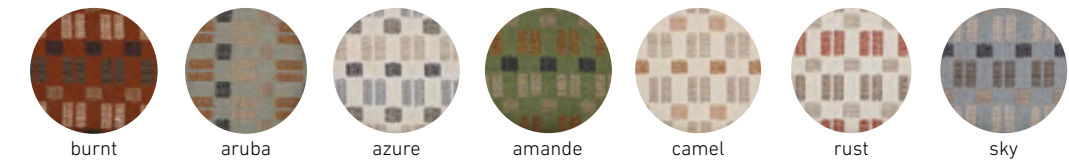

burnt aruba azure amande camel rust sky

BLOOM



ginger bark ladin night opal

Marine Leather

Marine Leather is a material often used in YAAZ's luxurious and durable furniture designs. Marine Leather stands out with its durable structure, while at the same time offering a comfortable use with its soft texture.

Cleaning and Using Instructions

Mix warm water and mild soap or a specialized cleaner for marine leather surfaces.

To remove stains, use a specially formulated leather cleaner or a lightly dampened cloth.

Moisturize your leather products regularly and care for them with a protective leather cream or polish to maintain the suppleness and shine of the leather.

Avoid exposing the furniture to extreme temperatures, such as direct sunlight or freezing temperatures.

Do not use abrasive materials or harsh chemicals when cleaning the furniture, as they can damage the marine leather.

To prevent scratches or tears, avoid dragging heavy objects across the surface of the furniture.

Consider covering the furniture during prolonged periods of non-use, such as during the winter months or when you are away on vacation.

Regularly inspect the furniture for any signs of damage or wear, and address any issues promptly to prevent further damage.

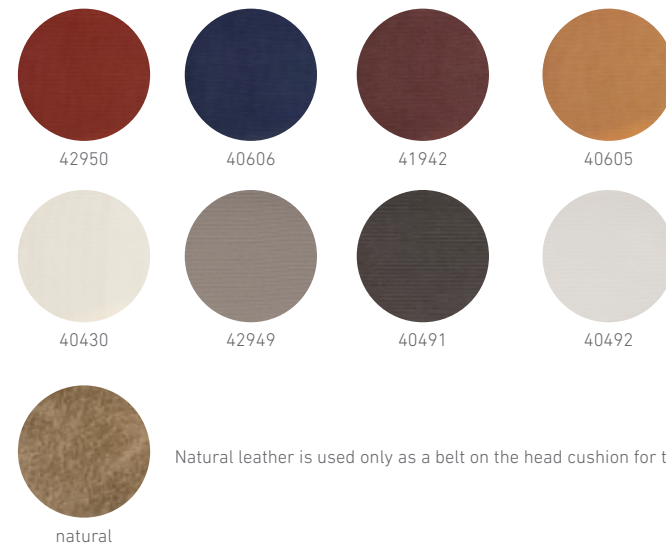

Natural leather is used only as a belt on the head cushion for the Uz Lounge Chair.

Serge Ferrari Sling / Mesh

Fabrics in the Batyline Elios range meet this need for sensorial comfort thanks to a soft touch, a textile look and a contemporary design.

The fabrics' high level of technical performance guarantees the furniture's durability. Batyline Elios, a time tested fabric.

Cleaning and Using Instructions

Brush off any loose dirt or debris from the surface of the fabric using a soft-bristled brush.

Apply a solution of water and mild soap to the fabric with a sponge or soft cloth.

Gently scrub the fabric in a circular motion, taking care not to rub too hard.



Softness and comfort

The flocked yarn in the weave ensures the fabric's softness and comfort



Robust

High - performance Batyline fabric with exceptional abrasion resistance properties (50,000 Martindale test cycles) for cushioning or tensioned installation (sling) applications

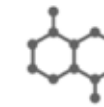

Easy cleaning

Batyline Elios is an excellent solution for outdoor furniture, combining durability and easy cleaning

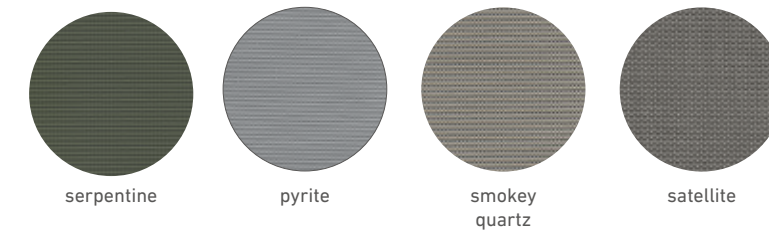



technical info

Typology

Chairs

Armchairs

Club chairs

Sofas

Sunbeds & Daybeds

Bar & Counter Stool

Tables

Coffee Tables

Stools

Gazebo

Modular Elements

Complements

• Carpet - Fire Pit - Swing - Flower Pot - Lighting - Pillows

Chairs



Turtle.11.S - Turtle.11.ST

TURTLE collection chairs are of three types: chairs with and without rope accessories in the backrest area and chairs without armrests. The legs of each type of chair can be made of teak or aluminum.

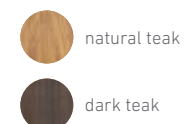
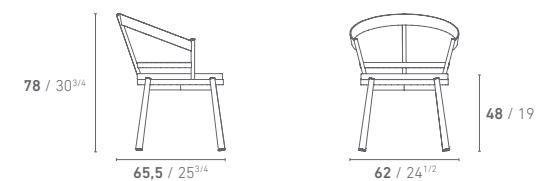

DIMENSIONS
product cm / inch: w. **62 / 24^{1/2}** d. **65,5 / 25^{3/4}** h. **78 / 30^{3/4}**
(with aluminum legs) weight: **9,5 kg / 20,9 lbs**
(with teak legs) weight: **10,8 kg / 23,8 lbs**
*Back cushions are optional

MATERIAL: Aluminum, Teak (optional), Fabric, Foam

Turtle.11 - Turtle.11.T

TURTLE collection chairs are of three types: chairs with and without rope accessories in the backrest area and chairs without armrests. The legs of each type of chair can be made of teak or aluminum.

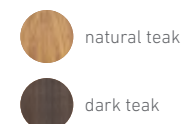
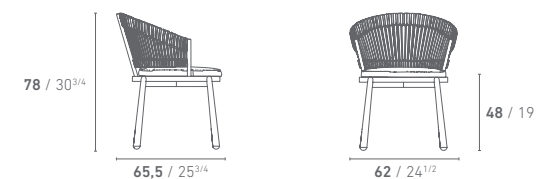

DIMENSIONS
product cm / inch: w. **62 / 24^{1/2}** d. **65,5 / 25^{3/4}** h. **78 / 30^{3/4}**
(with aluminum legs) weight: **10,6 kg / 23,4 lbs**
(with teak legs) weight: **12 kg / 26,5 lbs**
*Back cushions are optional

MATERIAL: Aluminum, Teak (optional), Rope, Fabric, Foam

Turtle.11.SA - Turtle.11.SAT

TURTLE collection chairs are of three types: chairs with and without rope accessories in the backrest area and chairs without armrests. The legs of each type of chair can be made of teak or aluminum.

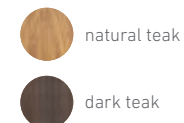
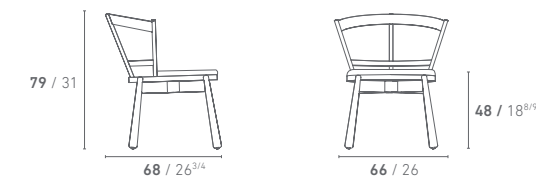

DIMENSIONS
product cm / inch: w. **66 / 26** d. **68 / 26^{3/4}** h. **79 / 31**
(with aluminum legs) weight: **9 kg / 19,8 lbs**
(with teak legs) weight: **12 kg / 26,5 lbs**
*Back cushions are optional

MATERIAL: Aluminum, Teak (optional), Fabric, Foam

Turtle.11.AR - Turtle.11.ART

TURTLE collection chairs are of three types: chairs with and without rope accessories in the backrest area and chairs without armrests. The legs of each type of chair can be made of teak or aluminum.

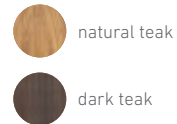
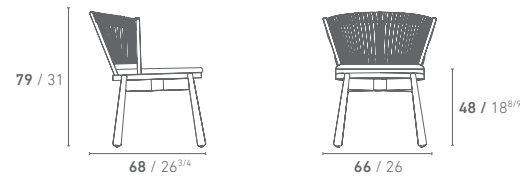

DIMENSIONS
 product cm / inch: w. **66 / 26** d. **68 / 26^{3/4}** h. **79 / 31**
 (with aluminum legs) weight: **10 kg / 22 lbs**
 (with teak legs) weight: **11,5 kg / 25,4 lbs**
 *Back cushions are optional
MATERIAL: Aluminum, Teak (optional), Rope, Fabric, Foam

Dedim.11

The collection of folding chairs is made of aluminium, interpreting a refined design concept, resulting in a triangular cross-section of the legs and armrests to guarantee maximum comfort and ergonomics. The chair, whose seat is enriched with a quilted and padded structure of Serge Ferrari fabrics, is available in three different options.

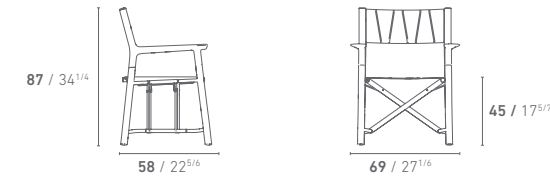

DIMENSIONS
 product cm / inch: w. **69 / 27^{1/6}** d. **58 / 22^{5/6}** h. **87 / 34^{1/4}**
 weight: **15,4 kg / 34 lbs**
MATERIAL: Aluminum, SF Sling*
 *only Serge Ferrari sling fabric is used

Uz.11

Structure is made of original teak wood, while YAAZ synthetic rope bands are used for outdoor applications. YAAZ rope is a yarn produced by the company that offers high protection against the sun and atmospheric agents.

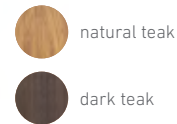
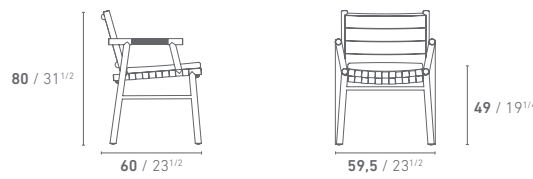

DIMENSIONS
 product cm / inch: w. **59,5 / 23^{1/2}** d. **60 / 23^{1/2}** h. **80 / 31^{1/2}**
 weight: **7 kg / 15,4 lbs**
MATERIAL: Teak, Rope, Band, Fabric, Foam

Dedim.11.T

In addition to being foldable, it is a chair that offers optional integrated accessories with an extendable tray and impresses with its sturdiness.

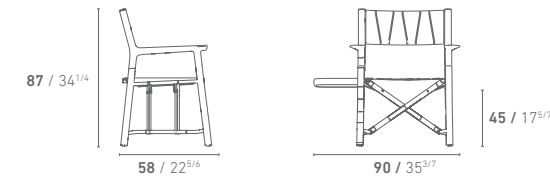

DIMENSIONS
 product cm / inch: w. **90 / 35^{3/7}** (table is open) d. **58 / 22^{5/6}** h. **87 / 34^{1/4}**
 weight: **18 kg / 39,7 lbs**
MATERIAL: Aluminum, SF Sling*
 *only Serge Ferrari sling fabric is used

Denk.11

Structure is made of original teak wood, while YAAZ synthetic rope bands are used for outdoor applications. YAAZ rope is a yarn produced by the company that offers high protection against the sun and atmospheric agents.

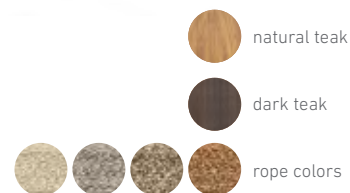
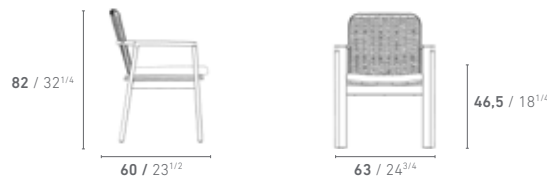

DIMENSIONS
 product cm / inch: w. **63 / 24^{3/4}** d. **60 / 23^{1/2}** h. **82 / 32^{1/4}**
 weight: **10 kg / 22,0 lbs**
MATERIAL: Teak, Rope, Fabric, Foam
 4 colors rope

Dedim.11.C

Wider and lower than the other pieces in the collection, it is more like a lounge chair than a chair, and its removable sunshade is unique for maximum comfort.

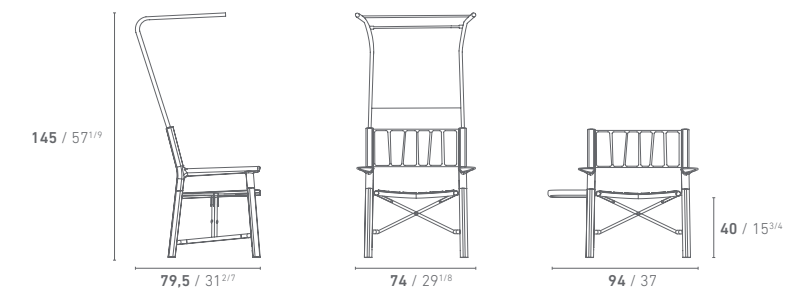

DIMENSIONS
 product cm / inch: w. **94 / 37** (table is open) d. **79,5 / 31^{2/7}** h. **145 / 57^{1/9}**
 weight: **20,2 kg / 44,5 lbs**
MATERIAL: Aluminum, SF Sling*
 *only Serge Ferrari sling fabric is used

Monte.11

It is practical because it is stackable. It can be interpreted in many different ways thanks to the diversity in the seat back. It is made entirely of aluminum. The armrest is manufactured with die casting technique. The chair has 3 different back alternatives.

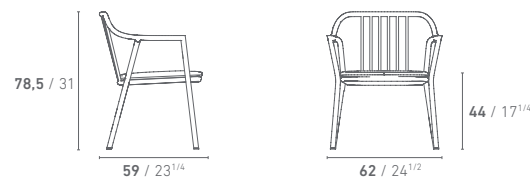
**DIMENSIONS**

product cm / inch: w. **62** / 24^{1/2} d. **59** / 23^{1/4} h. **78,5** / 31
weight: **7 kg** / 15,4 lbs
*Back cushions are optional

MATERIAL: Aluminum, Fabric, Foam

Monte.11.C

It is practical because it is stackable. It can be interpreted in many different ways thanks to the diversity in the seat back. It is made entirely of aluminum. The armrest is manufactured with die casting technique. The chair has 3 different back alternatives.

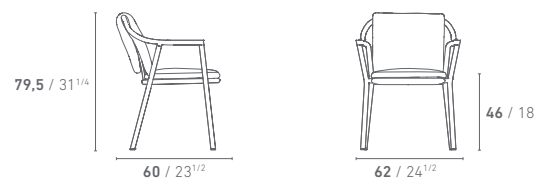
**DIMENSIONS**

product cm / inch: w. **62** / 24^{1/2} d. **60** / 23^{1/2} h. **79,5** / 31^{1/4}
weight: **7,2 kg** / 15,9 lbs

MATERIAL: Aluminum, Fabric, Foam

Monte.11.S

It is practical because it is stackable. It can be interpreted in many different ways thanks to the diversity in the seat back. It is made entirely of aluminum. The armrest is manufactured with die casting technique. The chair has 3 different back alternatives.

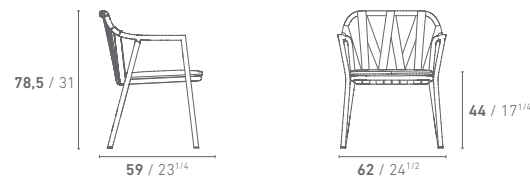
**DIMENSIONS**

product cm / inch: w. **62** / 24^{1/2} d. **59** / 23^{1/4} h. **78,5** / 31
weight: **6 kg** / 13,2 lbs
*Back cushions are optional

MATERIAL: Aluminum, Strap*, Fabric, Foam
*Strap (4 colors)

Barla.11

Comfortable, and enveloping, the BARLA chair is ideal for enjoying moments of conviviality in the open air because it combines design, comfort, and functionality. BARLA collection lends itself to countless interpretations from the point of view of colors and finishes.

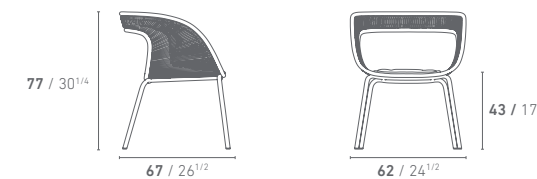
**DIMENSIONS**

product cm / inch: w. **62** / 24^{1/2} d. **67** / 26^{1/2} h. **77** / 30^{1/4}
weight: **8,8 kg** / 19,4 lbs

MATERIAL: Aluminum, Rope, Fabric, Foam

Edi.11 - Edi.11.T

The chairs are made entirely of aluminum. Comfortable and lightweight, suitable for all types of indoor and outdoor use in private homes and conventions. The EDI stackable chair can be made entirely of aluminum or optionally with a back made of genuine teak wood.

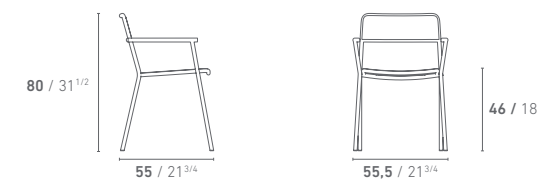
**DIMENSIONS**

product cm / inch: w. **55,5** / 21^{3/4} d. **55** / 21^{3/4} h. **80** / 31^{1/2}
(aluminum back) weight: **6 kg** / 13,2 lbs
(teak back) weight: **6,2 kg** / 13,7 lbs
*Cushions are optional

MATERIAL: Aluminum, Teak (optional), Fabric and Foam (optional)

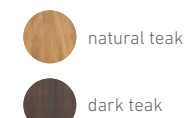
**Saye.11**

Foldable and easily transportable, the chair is cleverly designed with die-cast aluminum, where the opening and closing joint of the seat is designed with great lightness. The armrests are enriched with teak sections.

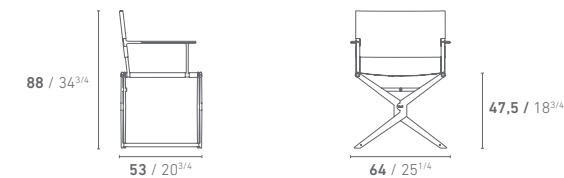
**DIMENSIONS**

product cm / inch: w. **64** / 25^{1/4} d. **53** / 20^{3/4} h. **88** / 34^{3/4}
weight: **8 kg** / 17,6 lbs

MATERIAL: Aluminum, Teak, SF Sling*
*only Serge Ferrari sling fabric is used

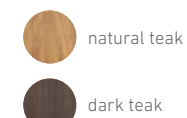

Armchairs



UZ

DENK

OVA

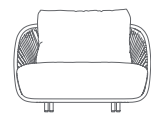

BARLA

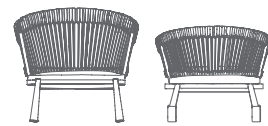

TURTLE

Uz.12

Structure is made of original teak wood, while YAAZ synthetic rope bands are used for outdoor applications. YAAZ rope is a yarn produced by the company that offers high protection against the sun and atmospheric agents.

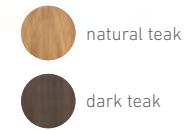
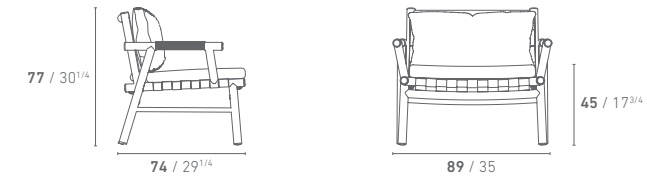

DIMENSIONS
 product cm / inch: w. **89 / 35** d. **74 / 29^{1/4}** h. **77 / 30^{1/4}**
 weight: **16,8 kg / 37,0 lbs**
 *Decorative cushions are optional

MATERIAL: Teak, Rope, Band, Fabric, Foam

Uz.10

The seatback of the chair is enriched with a headrest cushion offering a soft support which allows you to rest your head comfortably, favoring a sense of casual relaxation. It is completed with stylish accessories such as headrest cushion, aged leather straps and wooden buttons.

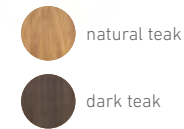
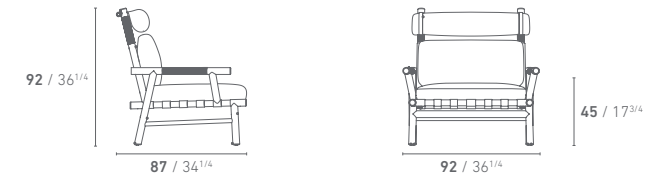

DIMENSIONS
 product cm / inch: w. **92 / 36^{1/4}** d. **87 / 34^{1/4}** h. **92 / 36^{1/4}**
 weight: **18,4 kg / 40,6 lbs**
 *Decorative cushions are optional

MATERIAL: Teak, Rope, Band, Fabric, Leather, Foam

Denk.12

Structure is made of original teak wood, while YAAZ synthetic rope bands are used for outdoor applications. YAAZ rope is a yarn produced by the company that offers high protection against the sun and atmospheric agents.

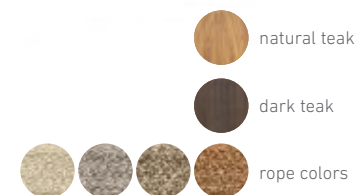
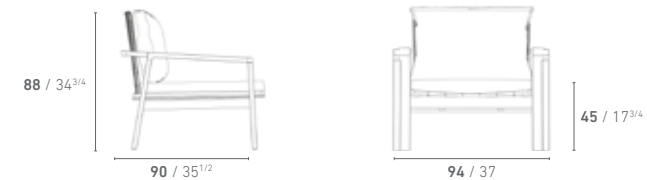

DIMENSIONS
 product cm / inch: w. **94 / 37** d. **90 / 35^{1/2}** h. **88 / 34^{3/4}**
 weight: **23,6 kg / 52,0 lbs**
 *Decorative cushions are optional

MATERIAL: Teak, Rope (4 colors), Fabric, Foam

Ova.12.AA

Ova Armchair is suitable for all combinations due to its overlapping backrest structure. Ova Armchair has three different variations for the backrest. All aluminum, Aluminum+Rope and Rope+Rope.

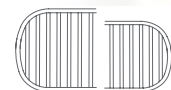
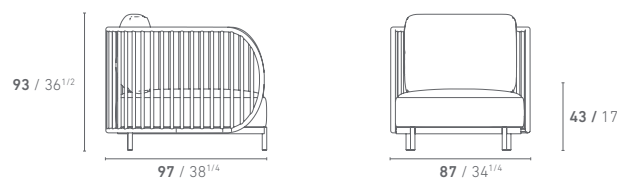

Back structure is made of aluminum and aluminum
Structure Aluminum (18 colors)
Backrest: Aluminum+Aluminum (18 colors)

DIMENSIONS

product cm / inch: w. **87 / 34^{1/4}** d. **97 / 38^{1/4}** h. **93 / 36^{1/2}**
weight: **27 kg / 59,5 lbs**
*Decorative cushions are optional

MATERIAL: Aluminum, Fabric, Foam

Ova.12.AR

Ova Armchair is suitable for all combinations due to its overlapping backrest structure. Ova Armchair has three different variations for the backrest. All aluminum, Aluminum+Rope and Rope+Rope.

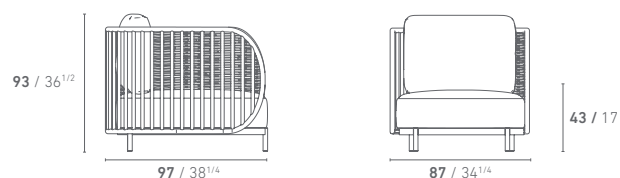

Back structure is made of rope and aluminum
Structure Aluminum (18 colors)
Backrest: Aluminum+Rope (18+18 colors)

DIMENSIONS

product cm / inch: w. **87 / 34^{1/4}** d. **97 / 38^{1/4}** h. **93 / 36^{1/2}**
weight: **29,4 kg / 64,8 lbs**
*Decorative cushions are optional

MATERIAL: Aluminum, Rope, Fabric, Foam

Ova.12.RR

Ova Armchair is suitable for all combinations due to its overlapping backrest structure. Ova Armchair has three different variations for the backrest. All aluminum, Aluminum+Rope and Rope+Rope.

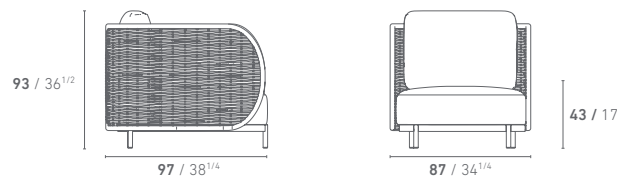

Back structure is made of rope and rope
Structure Aluminum (18 colors)
Backrest: Rope+Rope (18 colors)

DIMENSIONS

product cm / inch: w. **87 / 34^{1/4}** d. **97 / 38^{1/4}** h. **93 / 36^{1/2}**
weight: **31,8 kg / 70,1 lbs**
*Decorative cushions are optional

MATERIAL: Aluminum, Rope, Fabric, Foam

Barla.12

Two aluminum tubes, running always parallel to each other both in straight and in curved sections, define the wide and harmonious profile of the armchair. Among these, a rope weaving holds and hosts the wide cushions hinged to the structure.

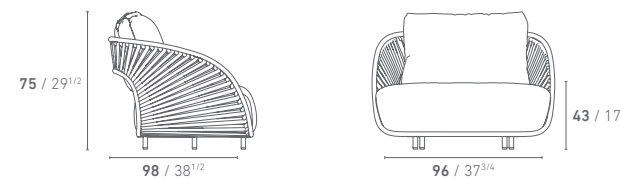

DIMENSIONS

product cm / inch: w. **96 / 37^{3/4}** d. **98 / 38^{1/2}** h. **75 / 29^{1/2}**
weight: **25 kg / 55,1 lbs**
*Decorative cushions are optional

MATERIAL: Aluminum, Rope, Fabric, Foam

Turtle.12 - Turtle.12.T

The collection is made entirely of aluminum and is durable enough to withstand harsh weather conditions. Optional legs can be made entirely of aluminum or teak. The armchair comes with seat and back cushions for added comfort and softness and can be easily removed for cleaning.

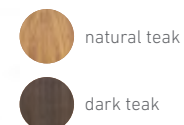
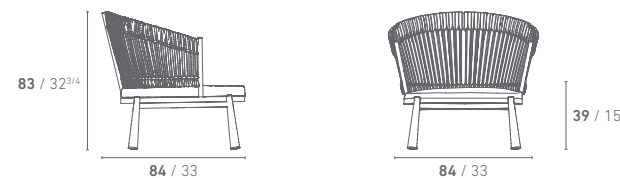

DIMENSIONS

product cm / inch: w. **84 / 33** d. **84 / 33** h. **83 / 32^{3/4}**
(with aluminum legs) weight: **17,8 kg / 39,2 lbs**
(with teak legs) weight: **18,2 kg / 40,1 lbs**

MATERIAL: Aluminum, Teak (optional), Rope, Fabric, Foam

Turtle.13

The rocking chair has a simple design that evokes the warmth and comfort of precious memories, such as a cozy cradle or mother's lap. The rocking chair comes with seat and back cushions for added comfort and softness and can be easily removed for cleaning.

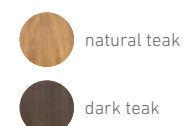
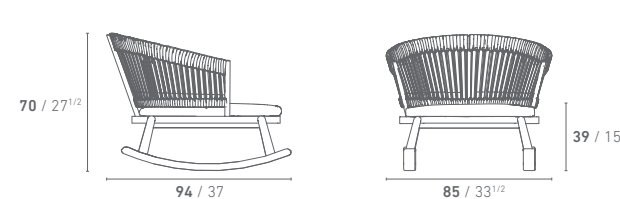

DIMENSIONS

product cm / inch: w. **85 / 33^{1/2}** d. **94 / 37** h. **70 / 27^{1/2}**
weight: **19,6 kg / 43,2 lbs**

MATERIAL: Aluminum, Teak, Rope, Fabric, Foam

Barla.9

Two aluminum tubes, running always parallel to each other both in straight and in curved sections, define the wide and harmonious profile of the armchair. Among these, a rope weaving holds and hosts the wide cushions hinged to the structure.

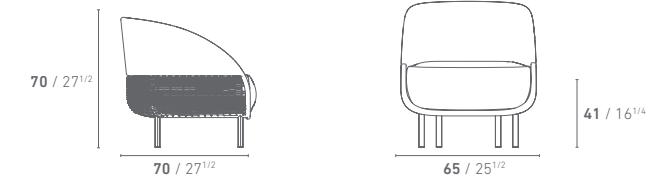
**DIMENSIONS**

product cm / inch: w. **65 / 25^{1/2}** d. **70 / 27^{1/2}** h. **70 / 27^{1/2}**

weight: **25 kg / 55,1 lbs**

*Decorative cushions are optional

MATERIAL: Aluminum, Rope, Fabric, Foam

Uz.9

The seatback of the chair is enriched with a headrest cushion offering a soft support which allows you to rest your head comfortably, favoring a sense of casual relaxation. It is completed with stylish accessories such as headrest cushion, aged leather straps and wooden buttons.

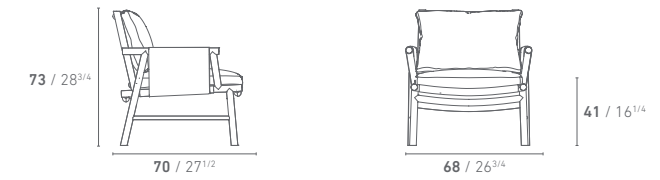
**DIMENSIONS**

product cm / inch: w. **68 / 26^{3/4}** d. **70 / 27^{1/2}** h. **73 / 28^{3/4}**

weight: **12 kg / 26,5 lbs**

*Decorative cushions are optional

MATERIAL: Teak, Fabric, Foam

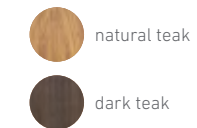
**Club chairs**

UZ

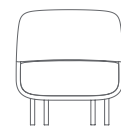

BARLA

Sofas

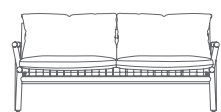

UZ

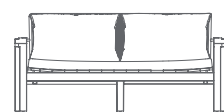

DENK

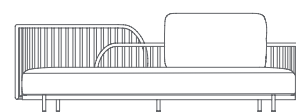

OVA

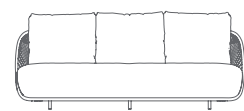

BARLA

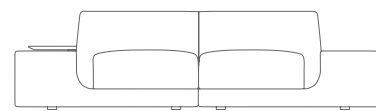

ADA

Uz.16

Structure is made of original teak wood, while YAAZ rope and bands are used for outdoor applications. With its iconic structure, it is planned for a session of 2 people. The seats and backrests are complemented by soft cushions with removable covers, which contribute to the overall feeling of comfort and relaxation.

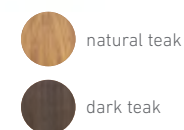
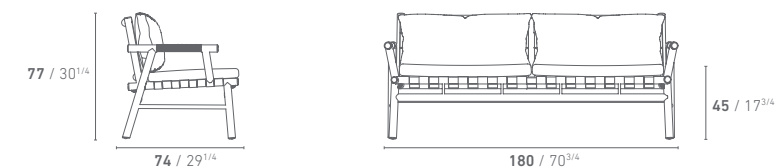

DIMENSIONS
product cm / inch: w. 180 / 70³/₄ d. 74 / 29¹/₄ h. 77 / 30¹/₄
weight: 32 kg / 70,5 lbs
*Decorative cushions are optional

MATERIAL: Teak, Rope, Band, Fabric, Foam

Denk.16.180

Structure is made of original teak wood, while YAAZ synthetic rope bands are used for outdoor applications. YAAZ rope is a yarn produced by the company that offers high protection against the sun and atmospheric agents.

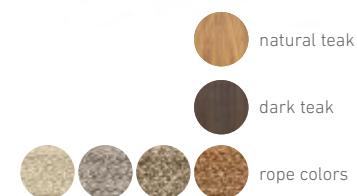
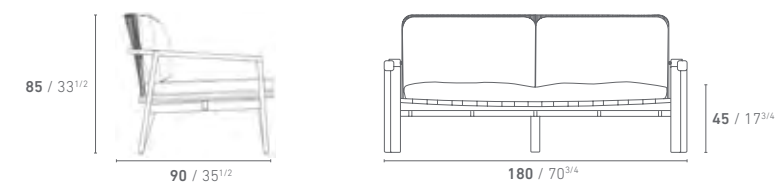

DIMENSIONS
product cm / inch: w. 180 / 70³/₄ d. 90 / 35¹/₂ h. 85 / 33¹/₂
weight: 44,5 kg / 98,10 lbs
*Decorative cushions are optional

MATERIAL: Teak, Rope (4 colors), Fabric, Foam

Denk.16.240

Structure is made of original teak wood, while YAAZ synthetic rope bands are used for outdoor applications. YAAZ rope is a yarn produced by the company that offers high protection against the sun and atmospheric agents.

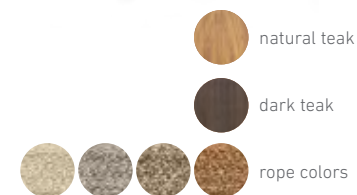
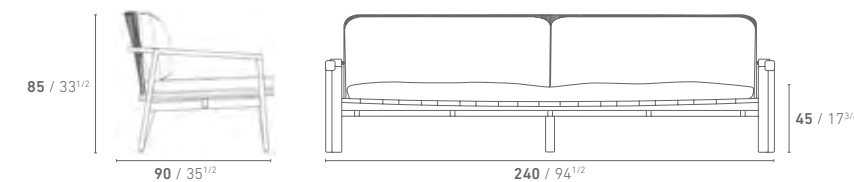

DIMENSIONS
product cm / inch: w. 240 / 94¹/₂ d. 90 / 35¹/₂ h. 85 / 33¹/₂
weight: 67 kg / 147,70 lbs
*Decorative cushions are optional

MATERIAL: Teak, Rope (4 colors), Fabric, Foam

Ova.16.190.AA

Ova Sofa is suitable for all combinations due to its overlapping backrest structure.
Ova Sofa 190 has three different variations for the backrest. All aluminum, Aluminum+Rope and Rope+Rope.

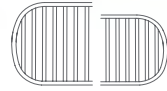
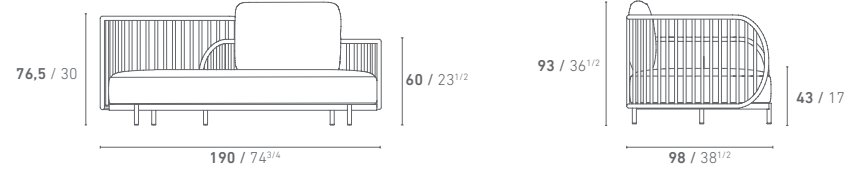

Back structure is made of aluminum and aluminum
Structure Aluminum (18 colors)
Backrest: Aluminum+Aluminum (18 colors)

DIMENSIONS

product cm / inch: w. **190 / 74^{3/4}** d. **98 / 38^{1/2}** h. **93 / 36^{1/2}**
weight: **55,4 kg / 122,10 lbs**
*Decorative cushions are optional

MATERIAL: Aluminum, Fabric, Foam

Ova.16.190.AR

Ova Sofa is suitable for all combinations due to its overlapping backrest structure.
Ova Sofa 190 has three different variations for the backrest. All aluminum, Aluminum+Rope and Rope+Rope.

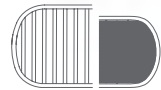
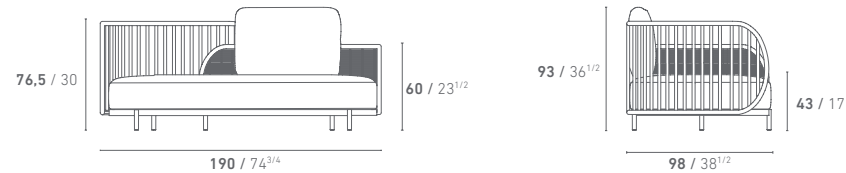

Back structure is made of rope and aluminum
Structure Aluminum (18 colors)
Backrest: Aluminum+Rope (18+18 colors)

DIMENSIONS

product cm / inch: w. **190 / 74^{3/4}** d. **98 / 38^{1/2}** h. **93 / 36^{1/2}**
weight: **58,6 kg / 129,2 lbs**
*Decorative cushions are optional

MATERIAL: Aluminum, Rope, Fabric, Foam

Ova.16.190.RR

Ova Sofa is suitable for all combinations due to its overlapping backrest structure.
Ova Sofa 190 has three different variations for the backrest. All aluminum, Aluminum+Rope and Rope+Rope.

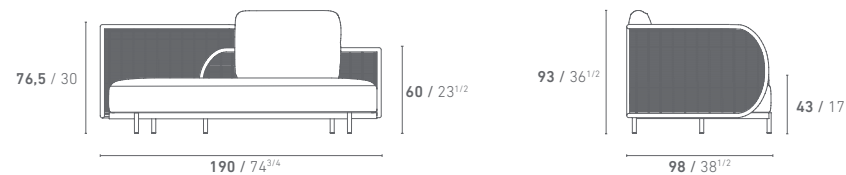

Back structure is made of rope and rope
Structure Aluminum (18 colors)
Backrest: Rope+Rope (18 colors)

DIMENSIONS

product cm / inch: w. **190 / 74^{3/4}** d. **98 / 38^{1/2}** h. **93 / 36^{1/2}**
weight: **61,8 kg / 136,2 lbs**
*Decorative cushions are optional

MATERIAL: Aluminum, Rope, Fabric, Foam

Ova.16.240.AA

Ova Sofa is suitable for all combinations due to its overlapping backrest structure.
Ova Sofa 240 has three different variations for the backrest. All aluminum, Aluminum+Rope and Rope+Rope.

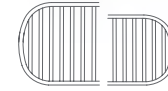
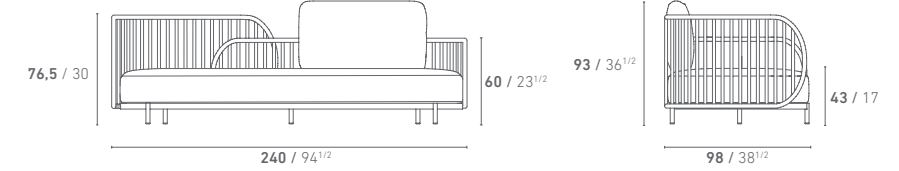

Back structure is made of aluminum and aluminum
Structure Aluminum (18 colors)
Backrest: Aluminum+Aluminum (18 colors)

DIMENSIONS

product cm / inch: w. **240 / 94^{1/2}** d. **98 / 38^{1/2}** h. **93 / 36^{1/2}**
weight: **60,8 kg / 134,0 lbs**
*Decorative cushions are optional

MATERIAL: Aluminum, Fabric, Foam

Ova.16.240.AR

Ova Sofa is suitable for all combinations due to its overlapping backrest structure.
Ova Sofa 240 has three different variations for the backrest. All aluminum, Aluminum+Rope and Rope+Rope.

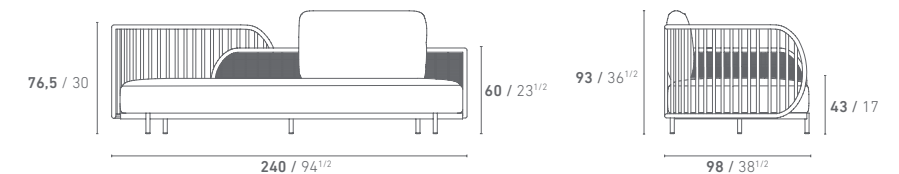

Back structure is made of rope and aluminum
Structure Aluminum (18 colors)
Backrest: Aluminum+Rope (18+18 colors)

DIMENSIONS

product cm / inch: w. **240 / 94^{1/2}** d. **98 / 38^{1/2}** h. **93 / 36^{1/2}**
weight: **64 kg / 141,1 lbs**
*Decorative cushions are optional

MATERIAL: Aluminum, Rope, Fabric, Foam

Ova.16.240.RR

Ova Sofa is suitable for all combinations due to its overlapping backrest structure.
Ova Sofa 240 has three different variations for the backrest. All aluminum, Aluminum+Rope and Rope+Rope.

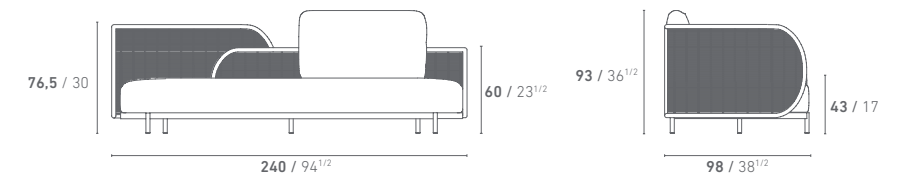

Back structure is made of rope and rope
Structure Aluminum (18 colors)
Backrest: Rope+Rope (18 colors)

DIMENSIONS

product cm / inch: w. **240 / 94^{1/2}** d. **98 / 38^{1/2}** h. **93 / 36^{1/2}**
weight: **67,8 kg / 149,5 lbs**
*Decorative cushions are optional

MATERIAL: Aluminum, Rope, Fabric, Foam

Barla.16.215

Structure in aluminum, YAAZ synthetic rope bands for outdoors, a yarn produced by the company with high protection to the sun and to the atmospheric agents. Sunbrella fabrics made of acrylic fibers for outdoor use.

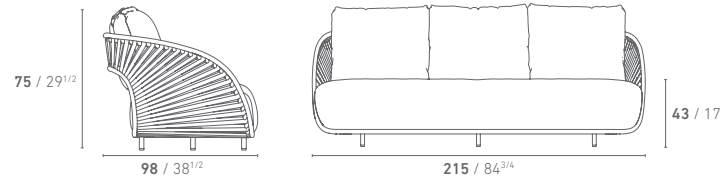

DIMENSIONS

product cm / inch: w. **215 / 84^{3/4}** d. **98 / 38^{1/2}** h. **75 / 29^{1/2}**

weight: **52 kg / 114,6 lbs**

*Decorative cushions are optional

MATERIAL: Aluminum structure, Rope, Fabric, Foam

Barla.16.265

Structure in aluminum, YAAZ synthetic rope bands for outdoors, a yarn produced by the company with high protection to the sun and to the atmospheric agents. Sunbrella fabrics made of acrylic fibers for outdoor use.

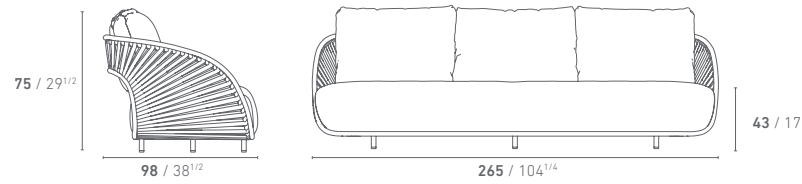

DIMENSIONS

product cm / inch: w. **265 / 104^{1/4}** d. **98 / 38^{1/2}** h. **75 / 29^{1/2}**

weight: **60 kg / 132,3 lbs**

*Decorative cushions are optional

MATERIAL: Aluminum structure, Rope, Fabric, Foam

Ada.16

Its entire internal structure is made of 7001 series aluminum used in the defense industry. The skeleton prepared without using resources has 2 sessions; soft and hard session. Designed for 360 degree comfort. There is a fixed serving tray made of natural teak wood on the hard seat side.

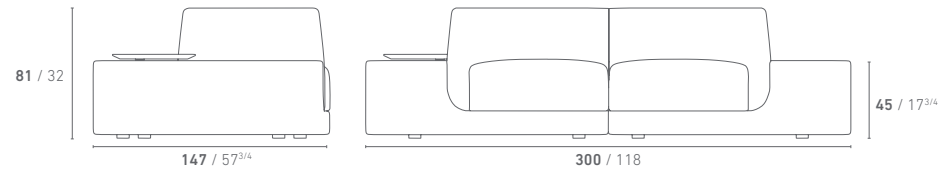

DIMENSIONS

product cm / inch: w. **300 / 118** d. **147 / 57^{3/4}** h. **81 / 32**

weight: **70,2 kg / 154,8 lbs**

MATERIAL: Aluminum structure, Teak/Z-pact service top, Fabric, Foam

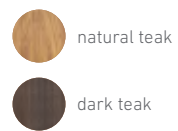

Sunbed & Daybeds

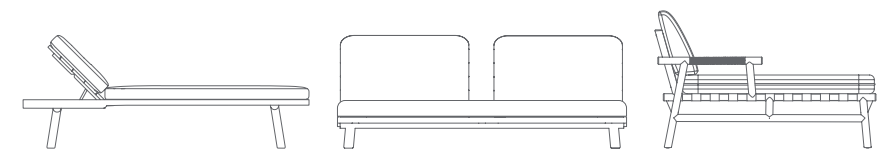

UZ

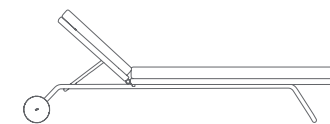

ANKA

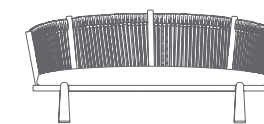

TURTLE

Uz.17

The Uz sunbed has a structure made entirely of original teak which makes it precious both from a material and functional point of view. The cot provides adjustment of the backrest, which, when raised, frees up a space with a container edge for storing towels, clothes, and personal items.

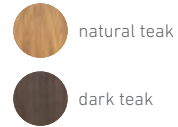
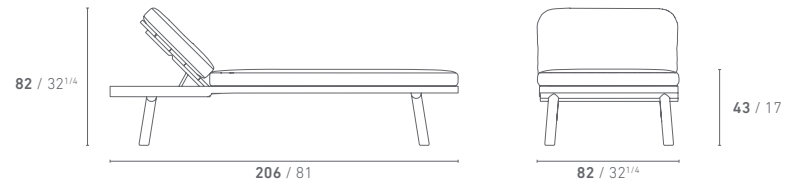

DIMENSIONS
product cm / inch: w. 206 / 81 d. 82 / 32¹/₄ h. 43 / 17
weight: 59,6 kg / 131,4 lbs

MATERIAL: Teak, Fabric, Foam

Anka.17

ANKA is a sunbed that can be easily moved thanks to the large rear wheels. It is made of aluminum which is a light weight and hard metal with excellent strength- to-weight ratio and corrosion resistance.

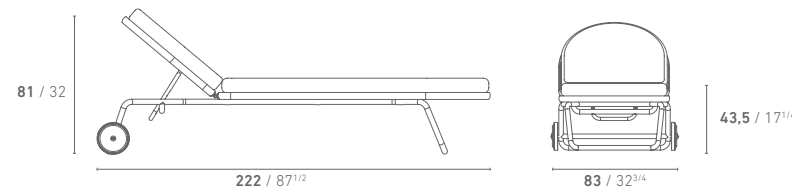

DIMENSIONS
product cm / inch: w. 222 / 87¹/₂ d. 83 / 32³/₄ h. 43,5 / 17¹/₄
weight: 43,2 kg / 95,2 lbs

MATERIAL: Aluminum, Stainless Steel, Fabric, Foam

Uz.17.Double

Double sunbed made entirely of original teak wood. With its iconic structure, it is planned for a session of 2 people. The cot allows for adjusting the backrest, which, when elevated, creates space with a container rim for storing towels, clothes and personal items.

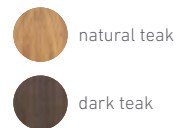
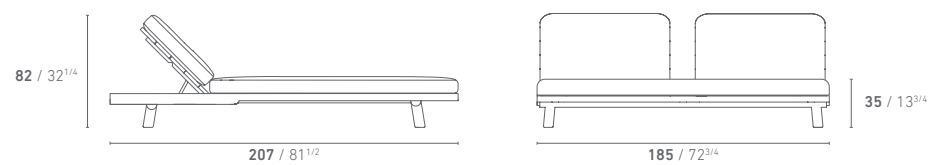

DIMENSIONS
product cm / inch: w. 185 / 72³/₄ d. 207 / 81¹/₂ h. 35 / 13³/₄
weight: 125 kg / 275,6 lbs

MATERIAL: Teak, Fabric, Foam

Uz.18

The Uz sunbed has a structure made entirely of original teak which makes it precious both from a material and functional point of view. The cot provides adjustment of the backrest, which, when raised, frees up a space with a container edge for storing towels, clothes, and personal items.

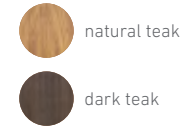
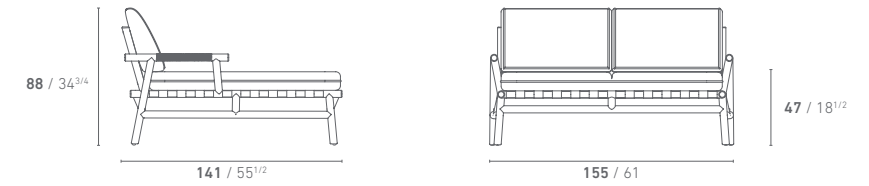

DIMENSIONS
product cm / inch: w. 155 / 61 d. 141 / 55¹/₂ h. 88 / 34³/₄
weight: 45 kg / 99,2 lbs

MATERIAL: Teak, Rope, Band, Fabric, Foam

Turtle.18

It provides unique comfort with its round shape and aluminum frame that stands firmly on the ground. The backrests of the daybed in the TURTLE collection are available in either aluminum or a combination of aluminum and woven ropes.

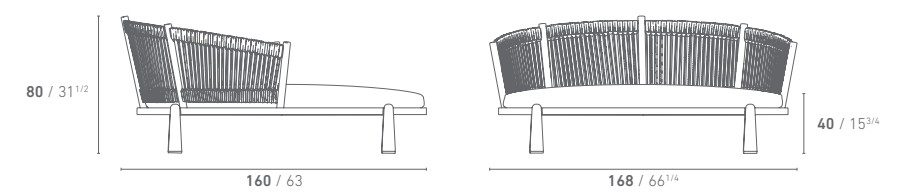

DIMENSIONS
product cm / inch: w. 168 / 66¹/₄ d. 160 / 63 h. 80 / 31¹/₂
weight: 66 kg / 145,5 lbs

MATERIAL: Aluminum, Rope, Fabric, Foam

Barla.15.Counter - Barla.15.Stool

BARLA stools made of aluminum and with rope backrest are available in two heights.

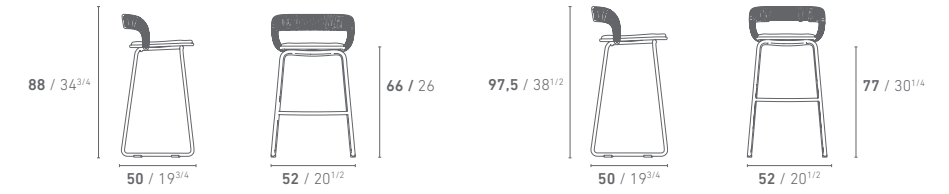

DIMENSIONS

product cm / inch: w. **52 / 20^{1/2}** d. **50 / 19^{3/4}** h. **88 / 34^{3/4}** / h. **97,5 / 38^{1/2}**

weight: **7 kg / 15,4 lbs** / **7,2 kg / 15,9 lbs**

MATERIAL: Aluminum, Rope, Fabric, Foam, Stainless Steel

Turtle.15.S - Turtle.15

The backrests of the stools in the TURTLE collection are available in either aluminum or a combination of aluminum and woven ropes. The footrests are reinforced with stainless material.

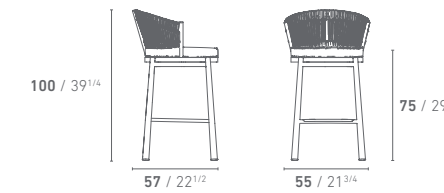

DIMENSIONS

product cm / inch: w. **55 / 21^{3/4}** d. **57 / 22^{1/2}** h. **100 / 39^{1/4}**
weight: **9 kg / 19,8 lbs** - **9,6 kg / 21,2 lbs**

MATERIAL: Aluminum, Rope, Fabric, Foam, Stainless Steel

Turtle.15.S.Counter - Turtle.15.Counter

The backrests of the stools in the TURTLE collection are available in either aluminum or a combination of aluminum and woven ropes. The footrests are reinforced with stainless material.

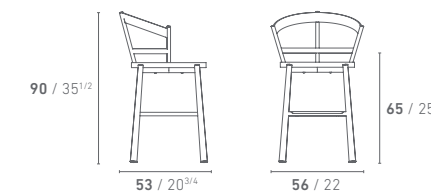

DIMENSIONS

product cm / inch: w. **56 / 22** d. **53 / 20^{3/4}** h. **90 / 35^{1/2}**
weight: **7,5 kg / 16,5 lbs** - **8 kg / 17,6 lbs**

MATERIAL: Aluminum, Rope, Fabric, Foam, Stainless Steel

Bar Stools

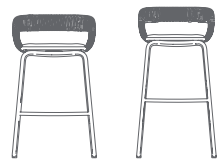

BARLA

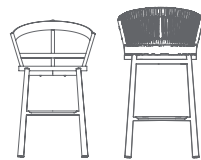

TURTLE

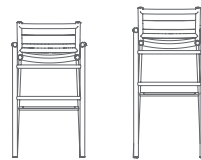

UZ

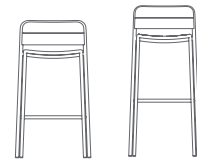

EDI

Uz.15.Counter - Uz.Bar

The structure is made of original teak wood, YAAZ ropes and tapes are used for outdoor applications. It is offered with its iconic structure and 2 different sizes. The cushions are completed with soft cushions with removable covers that contribute to the overall sense of comfort and relaxation.

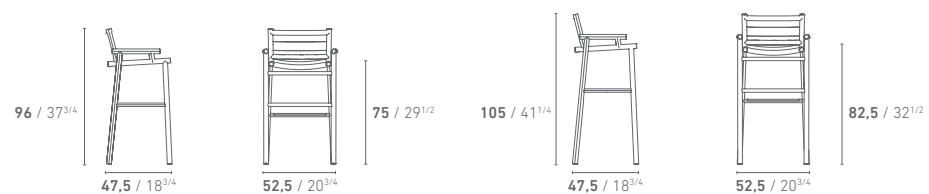
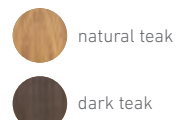

DIMENSIONS
 product cm / inch: w. 52,5 / 20³/₄ d. 47,5 / 18³/₄ h. 96 / 37³/₄ / h. 105 / 41¹/₄
 weight: - kg / - lbs - 9,6 kg / 21,2 lbs

MATERIAL: Teak, Rope, Fabric, Foam, Stainless Steel

Edi.15.C - Edi.15.CT

The chairs are made entirely of aluminum. Comfortable, and light, they are suitable for any indoor and outdoor use in private homes and contracts. EDI stools can be made entirely of aluminum or with the backrest in original teak. 2 different heights are available. Counter and Stools (h: 85 and h: 95 cm).

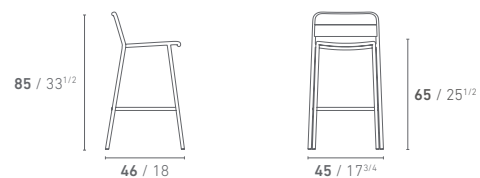
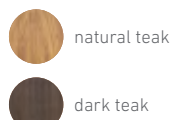

DIMENSIONS
 product cm / inch: w. 45 / 17³/₄ d. 46 / 18 h. 85 / 33¹/₂
 weight: 7,4 kg / 16,3 lbs / 7,6 kg / 16,8 lbs
 Cushion is optional

MATERIAL: Aluminum, Teak (optional), Stainless Steel

Edi.15 - Edi.15.T

The backrests of the stools in the TURTLE collection are available in either aluminum or a combination of aluminum and woven ropes. The footrests are reinforced with stainless material.

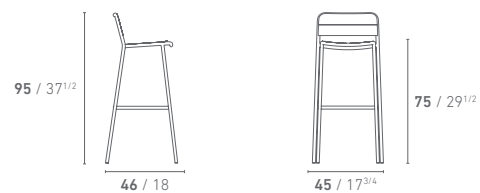
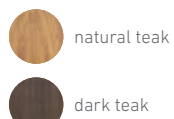

DIMENSIONS
 product cm / inch: w. 45 / 17³/₄ d. 46 / 18 h. 95 / 37¹/₂
 weight: 7,8 kg / 17,2 lbs - 8 kg / 17,6 lbs
 Cushion is optional

MATERIAL: Aluminum, Teak (optional), Stainless Steel

Tables



UZ

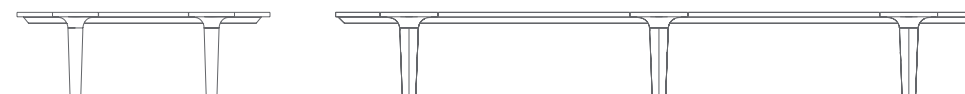

SEMT

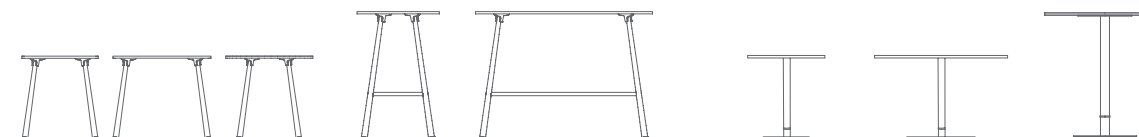

TURTLE

ANKA



BARLA

Uz.33.R120

The legs of the table can be closed, which facilitates the shipment of the product and adds value for those who intend to put away the table for the winter season. The table is available in two sizes: Around shape of Ø140 cm (55 inch) and Ø120 cm (47^{1/4} inch) in diameter. Structure is made of original teak wood.

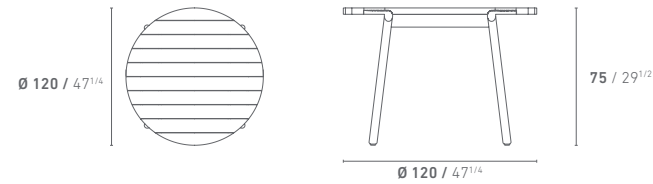

 natural teak

 dark teak

DIMENSIONS

product cm / inch: Ø 120 / 47^{1/4} d. 120 / 47^{1/4} h. 75 / 29^{1/2}
weight: 45 kg / 99,2 lbs

MATERIAL: Teak

for 4 seats

**Uz.33.220**

The legs of the table can be closed, which facilitates the shipment of the product and adds value for those who intend to put away the table for the winter season. The table is available in three sizes: 180x90 (70^{3/4} x 35^{1/2} inch), 220x100 (86^{1/2} x 39^{1/4} inch), 250x100 (98^{1/2} x 39^{1/4} inch) cm and in around shape of 140 cm (55 inch) and 120 cm (47^{1/4} inch) in diameter. Structure is made of original teak wood.

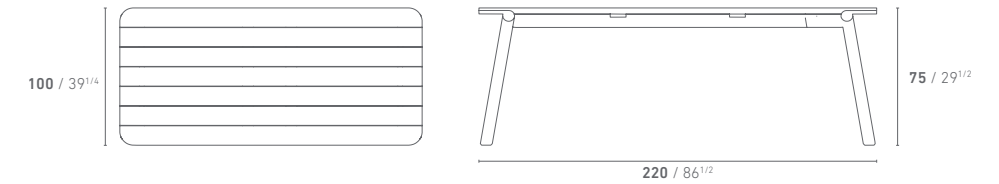

 natural teak

 dark teak

DIMENSIONS

product cm / inch: w. 220 / 86^{1/2} d. 100 / 39^{1/4} h. 75 / 29^{1/2}
weight: 68,5 kg / 151,0 lbs

MATERIAL: Teak

for 8 seats

**Uz.33.R140**

The legs of the table can be closed, which facilitates the shipment of the product and adds value for those who intend to put away the table for the winter season. The table is available in two sizes: Around shape of Ø140 cm (55 inch) and Ø120 cm (47^{1/4} inch) in diameter. Structure is made of original teak wood.

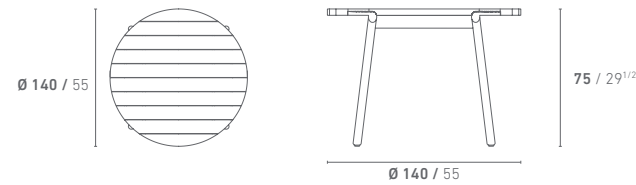

 natural teak

 dark teak

DIMENSIONS

product cm / inch: Ø 140 / 55 d. 140 / 55 h. 75 / 29^{1/2}
weight: 50,2 kg / 110,7 lbs

MATERIAL: Teak

for 6 seats

**Uz.33.250**

The legs of the table can be closed, which facilitates the shipment of the product and adds value for those who intend to put away the table for the winter season. The table is available in three sizes: 180x90 (70^{3/4} x 35^{1/2} inch), 220x100 (86^{1/2} x 39^{1/4} inch), 250x100 (98^{1/2} x 39^{1/4} inch) cm and in around shape of 140 cm (55 inch) and 120 cm (47^{1/4} inch) in diameter. Structure is made of original teak wood.

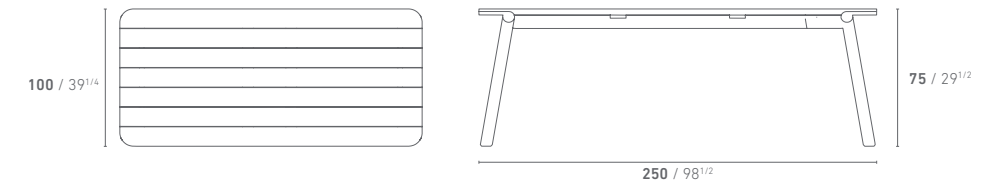

 natural teak

 dark teak

DIMENSIONS

product cm / inch: w. 250 / 98^{1/2} d. 100 / 39^{1/4} h. 75 / 29^{1/2}
weight: 78,2 kg / 172,4 lbs

MATERIAL: Teak

for 8 seats

**Uz.33.180**

The legs of the table can be closed, which facilitates the shipment of the product and adds value for those who intend to put away the table for the winter season. The table is available in three sizes: 180x90 (70^{3/4} x 35^{1/2} inch), 220x100 (86^{1/2} x 39^{1/4} inch), 250x100 (98^{1/2} x 39^{1/4} inch) cm and in around shape of 140 cm (55 inch) and 120 cm (47^{1/4} inch) in diameter. Structure is made of original teak wood.

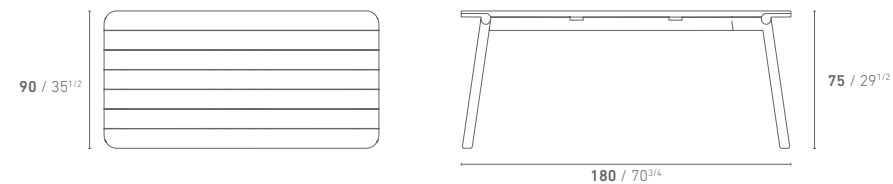

 natural teak

 dark teak

DIMENSIONS

product cm / inch: w. 180 / 70^{3/4} d. 90 / 35^{1/2} h. 75 / 29^{1/2}
weight: 52,3 kg / 115,3 lbs

MATERIAL: Teak

for 6 seats

**Semt.33.280**

The connecting parts on the legs of SEMT tables made of natural teak wood; aluminum and fiber mixture casting material produced with a special molding method, is completed with sprayed concrete material that provides resistance to bad weather conditions and intensive use.

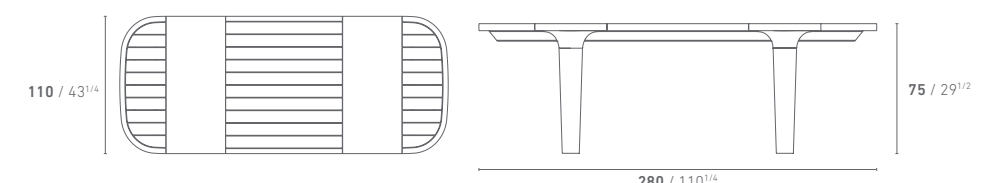

 natural teak

 dark teak

DIMENSIONS

product cm / inch: w. 280 / 110^{1/4} d. 110 / 43^{1/4} h. 75 / 29^{1/2}
weight with: 139 kg / 306,4 lbs

MATERIAL: Teak, Cement

There are 3 Coating Concrete colors of cement legs*

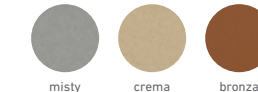

for 8 seats



Semt.33.350

The connecting parts on the legs of SEMT tables made of natural teak wood; aluminum and fiber mixture casting material produced with a special molding method, is completed with sprayed concrete material that provides resistance to bad weather conditions and intensive use.



- natural teak
- dark teak

DIMENSIONS
product cm / inch: w. **350 / 137^{3/4}** d. **110 / 43^{1/4}** h. **75 / 29^{1/2}**
weight with: **173 kg / 381,4 lbs**

MATERIAL: Teak, Cement

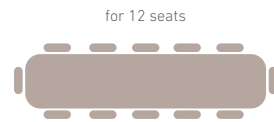
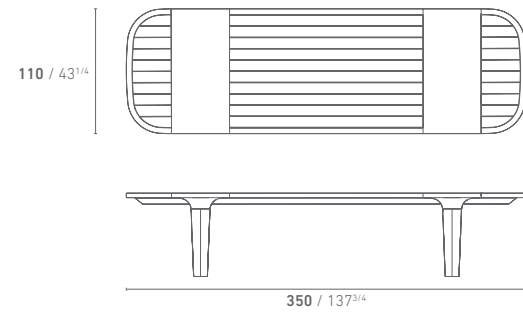

Semt.33.400

The connecting parts on the legs of SEMT tables made of natural teak wood; aluminum and fiber mixture casting material produced with a special molding method, is completed with sprayed concrete material that provides resistance to bad weather conditions and intensive use.



- natural teak
- dark teak

DIMENSIONS
product cm / inch: w. **400 / 157^{1/2}** d. **110 / 43^{1/4}** h. **75 / 29^{1/2}**
weight with: **198 kg / 436,5 lbs**

MATERIAL: Teak, Cement

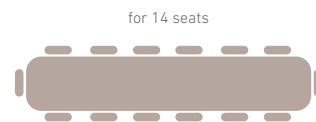
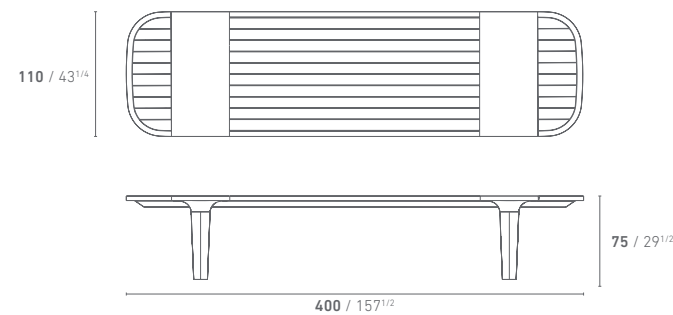

Semt.33.570

The connecting parts on the legs of SEMT tables made of natural teak wood; aluminum and fiber mixture casting material produced with a special molding method, is completed with sprayed concrete material that provides resistance to bad weather conditions and intensive use.



- natural teak
- dark teak

DIMENSIONS
product cm / inch: w. **570 / 224^{1/2}** d. **110 / 43^{1/4}** h. **75 / 29^{1/2}**
weight with: **334,5 kg / 737,4 lbs**

MATERIAL: Teak, Cement

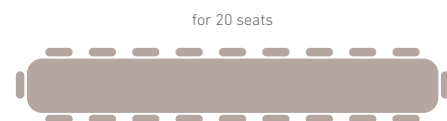
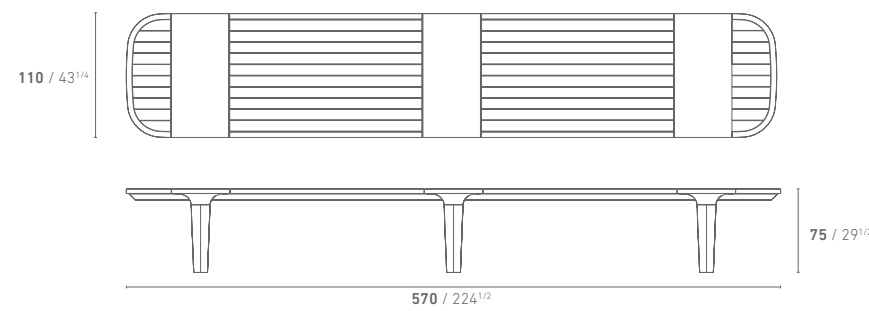

Turtle.33.70

Also ideal for contract use, the TURTLE table, which is available in three different sizes: 90x90cm (35^{2/4}x 35^{2/4} inch), 70x70 cm (27^{2/4}x 27^{2/4} inch) and 80 cm in diameter (Ø 31^{2/4} inch).

The table is made entirely of aluminum, making it light weight and durable. The legs are also removable to facilitate easier and more sustainable transport.



Table Top Alternatives
•aluminum
•z-pact

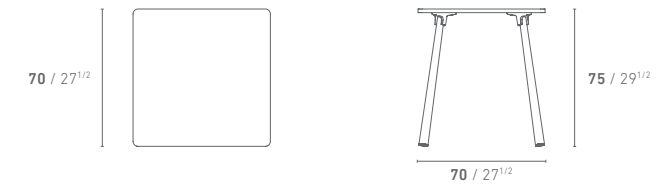

DIMENSIONS
product cm / inch: w. **70 / 27^{1/2}** d. **70 / 27^{1/2}** h. **75 / 29^{1/2}**
weight: alu top: **12 kg / 26,5 lbs** / z-pact top: **16,6 kg / 36,6 lbs**

MATERIAL: Aluminum, Z-pact (optional)

Turtle.33.R80

Also ideal for contract use, the TURTLE table, which is available in three different sizes: 90x90cm (35^{2/4}x 35^{2/4} inch), 70x70 cm (27^{2/4}x 27^{2/4} inch) and 80 cm in diameter (Ø 31^{2/4} inch).

The table is made entirely of aluminum, making it light weight and durable. The legs are also removable to facilitate easier and more sustainable transport.



Table Top Alternatives
•aluminum
•z-pact

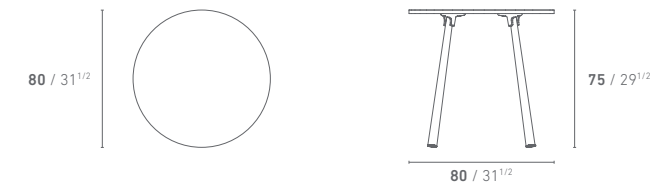

DIMENSIONS
product cm / inch: Ø. **80 / 31^{1/2}** d. **80 / 31^{1/2}** h. **75 / 29^{1/2}**
weight: **11,8 kg / 26 lbs** / z-pact top: **16,4 kg / 36,2 lbs**

MATERIAL: Aluminum, Z-pact (optional)

Turtle.33.90

Also ideal for contract use, the TURTLE table, which is available in three different sizes: 90x90cm (35^{2/4}x 35^{2/4} inch), 70x70 cm (27^{2/4}x 27^{2/4} inch) and 80 cm in diameter (Ø 31^{2/4} inch).

The table is made entirely of aluminum, making it light weight and durable. The legs are also removable to facilitate easier and more sustainable transport.



Table Top Alternatives
•aluminum
•z-pact

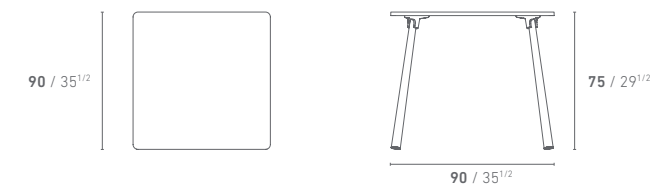

DIMENSIONS
product cm / inch: w. **90 / 35^{1/2}** d. **90 / 35^{1/2}** h. **75 / 29^{1/2}**
weight: **16 kg / 35,3 lbs** / z-pact top: **20,6 kg / 45,4 lbs**

MATERIAL: Aluminum, Z-pact (optional)

Anka.33.R70

The table leg, which consists of 3 pieces, can be configured with different color combinations. The part that sits on the base is made of heavy-duty stainless material that is resistant to weather conditions. Aluminum, z-pact and pavement alternatives are available for the table. It is offered with 2 different foot types. Ø42 cm and Ø62 cm.

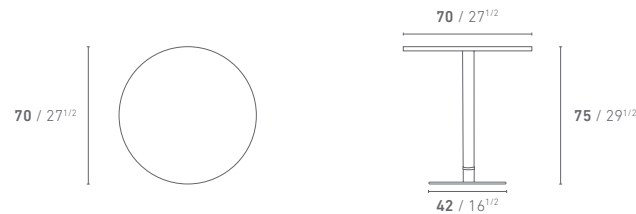
**Table Top Alternatives**

- aluminum
- z-pact
- ment

DIMENSIONS

product cm / inch: Ø. **70** / 27^{1/2} d. **70** / 27^{1/2} h. **75** / 29^{1/2}
weight: alu top: **26 kg** / 57,3 lbs / z-pact top: **29,6 kg** / 65,3 lbs / ment top: **41 kg** / 90,4 lbs

MATERIAL: Aluminum, Stainless Steel, Z-pact/Ment (optional)

Anka.33.70

The table leg, which consists of 3 pieces, can be configured with different color combinations. The part that sits on the base is made of heavy-duty stainless material that is resistant to weather conditions. Aluminum, z-pact and pavement alternatives are available for the table. It is offered with 2 different foot types. Ø42 cm and Ø62 cm.

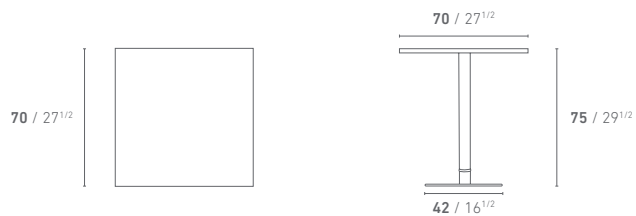
**Table Top Alternatives**

- aluminum
- z-pact
- ment

DIMENSIONS

product cm / inch: w. **70** / 27^{1/2} d. **70** / 27^{1/2} h. **75** / 29^{1/2}
weight: alu top: **27,6 kg** / 60,8 lbs / z-pact top: **31,5 kg** / 69,4 lbs / ment top: **43,6 kg** / 96,1 lbs

MATERIAL: Aluminum, Stainless Steel, Z-pact/Ment (optional)

Anka.33.R80

The table leg, which consists of 3 pieces, can be configured with different color combinations. The part that sits on the base is made of heavy-duty stainless material that is resistant to weather conditions. Aluminum, z-pact and pavement alternatives are available for the table. It is offered with 2 different foot types. Ø42 cm and Ø62 cm.

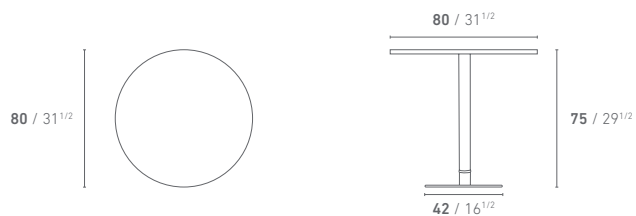
**Table Top Alternatives**

- aluminum
- z-pact
- ment

DIMENSIONS

product cm / inch: Ø. **80** / 31^{1/2} d. **80** / 31^{1/2} h. **75** / 29^{1/2}
weight: alu top: **27 kg** / 59,5 lbs / z-pact top: **32,2 kg** / 71,0 lbs / ment top: **49 kg** / 108 lbs

MATERIAL: Aluminum, Stainless Steel, Z-pact/Ment (optional)

Anka.33.80

The table leg, which consists of 3 pieces, can be configured with different color combinations. The part that sits on the base is made of heavy-duty stainless material that is resistant to weather conditions. Aluminum, z-pact and pavement alternatives are available for the table. It is offered with 2 different foot types. Ø42 cm and Ø62 cm.

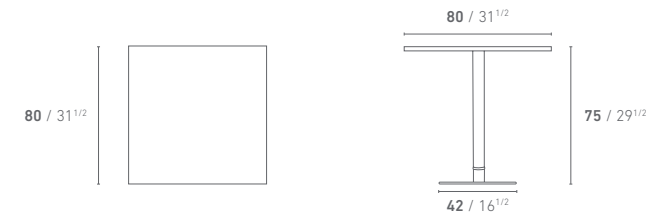
**Table Top Alternatives**

- aluminum
- z-pact
- ment

DIMENSIONS

product cm / inch: w. **80** / 31^{1/2} d. **80** / 31^{1/2} h. **75** / 29^{1/2}
weight: alu top: **28,6 kg** / 63 lbs / z-pact top: **34,31 kg** / 75,6 lbs / ment top: **52,1 kg** / 114,9 lbs

MATERIAL: Aluminum, Stainless Steel, Z-pact/Ment (optional)

Anka.33.90

The table leg, which consists of 3 pieces, can be configured with different color combinations. The part that sits on the base is made of heavy-duty stainless material that is resistant to weather conditions. Aluminum, z-pact and pavement alternatives are available for the table. It is offered with 2 different foot types. Ø42 cm and Ø62 cm.

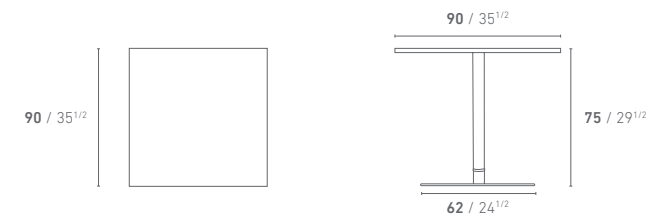
**Table Top Alternatives**

- aluminum
- z-pact

DIMENSIONS

product cm / inch: w. **90** / 35^{1/2} d. **90** / 35^{1/2} h. **75** / 29^{1/2}
weight: alu top: **33 kg** / 72,8 lbs / z-pact top: **40,5 kg** / 89,3 lbs

MATERIAL: Aluminum, Stainless Steel, Z-pact (optional)

Anka.33.R100

The table leg, which consists of 3 pieces, can be configured with different color combinations. The part that sits on the base is made of heavy-duty stainless material that is resistant to weather conditions. Aluminum, z-pact and pavement alternatives are available for the table. It is offered with 2 different foot types. Ø42 cm and Ø62 cm.

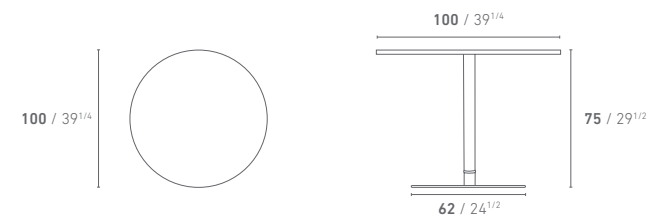
**Table Top Alternatives**

- z-pact
- ment

DIMENSIONS

product cm / inch: Ø. **100** / 39^{1/4} d. **100** / 39^{1/4} h. **75** / 29^{1/2}
weight: z-pact top: **43 kg** / 94,8 lbs / ment top: **75 kg** / 165,30 lbs

MATERIAL: Aluminum, Stainless Steel, Z-pact/Ment (optional)

Anka.33.R120

The table leg, which consists of 3 pieces, can be configured with different color combinations. The part that sits on the base is made of heavy-duty stainless material that is resistant to weather conditions. Aluminum, z-pact and pavement alternatives are available for the table. It is offered with 2 different foot types. Ø42 cm and Ø62 cm.

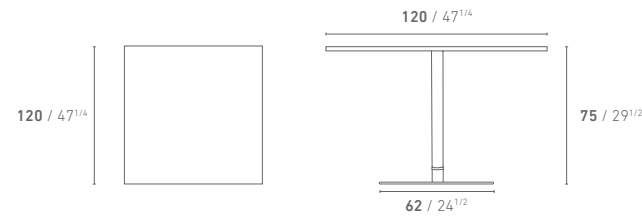

Table Top Only
•z-pact

DIMENSIONS

product cm / inch: Ø. **120 / 47^{1/4}** d. **120 / 47^{1/4}** h. **75 / 29^{1/2}**
weight: z-pact top: **47,3 kg / 104,30 lbs**

MATERIAL: Aluminum, Stainless Steel, Z-pact

Barla.33.250.ment - Barla.33.250.z-pact

The table follows an elongated profile that is composed in an oval shape. The aluminum structure is characterized by a round insert in Pavement, a composite material with a mottled appearance obtained by a mixture of fragments of marble, granite, basalt, and metal in a cement matrix, or HPL. It is produced in two sizes: 250 cm / 98^{1/2} inch and 300 cm / 118 inch

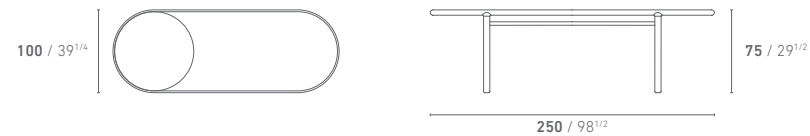
**DIMENSIONS**

product cm / inch: w. **250 / 98^{1/2}** d. **100 / 39^{1/4}** h. **75 / 29^{1/2}**
weight: **74,2 kg / 163,6 lbs / 65,8 kg / 145,10 lbs**

MATERIAL: Aluminum, Ment / Z-pact (optional)

Service Top Alternatives

•z-pact
•ment

for 6 seats

**Barla.33.300.ment - Barla.33.300.z-pact**

The table follows an elongated profile that is composed in an oval shape. The aluminum structure is characterized by a round insert in Pavement, a composite material with a mottled appearance obtained by a mixture of fragments of marble, granite, basalt, and metal in a cement matrix, or HPL. It is produced in two sizes: 250 cm / 98^{1/2} inch and 300 cm / 118 inch

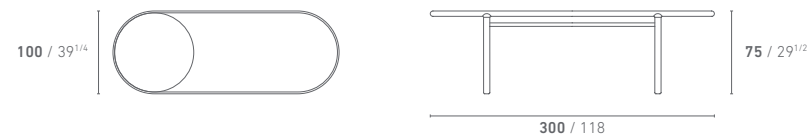
**DIMENSIONS**

product cm / inch: w. **300 / 118** d. **100 / 39^{1/4}** h. **75 / 29^{1/2}**
weight: **80 kg / 176,4 lbs / 73 kg / 160,9 lbs**

MATERIAL: Aluminum, Ment / Z-pact (optional)

Service Top Alternatives

•z-pact
•ment

for 8 seats

**Turtle.31.R70-Bar**

Ideal also for contract use, the TURTLE bar table is available in one size. 70x70 cm (27^{2/4}x 27^{2/4} inches). The table is made entirely of aluminium, which makes it light and durable. The legs are also removable to facilitate easier and more sustainable transport.

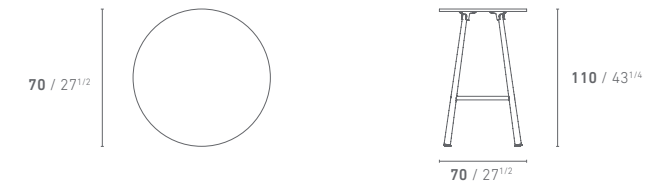
**Table Top Alternatives**

•aluminum
•z-pact

DIMENSIONS

product cm / inch: Ø. **70 / 27^{1/2}** d. **70 / 27^{1/2}** h. **110 / 43^{1/4}**
weight: **13,2 kg / 29,1 lbs / z-pact top: 13,7 kg / 30,2 lbs**

MATERIAL: Aluminum, Z-pact (optional)

Turtle.31.DESK

The table is made entirely of aluminum, making it light weight and durable. The legs are also removable to facilitate easier and more sustainable transport.

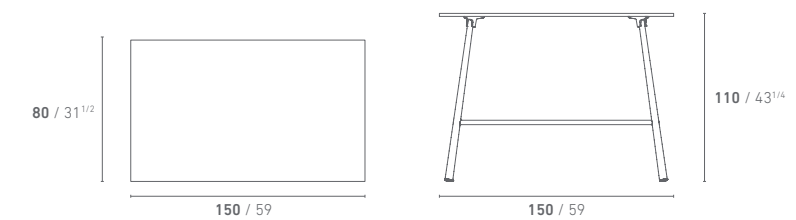
**DIMENSIONS**

product cm / inch: w. **150 / 59** d. **80 / 31^{1/2}** h. **110 / 43^{1/4}**
weight: **23,8 kg / 52,5 lbs**

MATERIAL: Aluminum

Anka.31.Bistro

The table is made entirely of aluminum, making it light weight and durable. The legs are also removable to facilitate easier and more sustainable transport.

**DIMENSIONS**

product cm / inch: w. **80 / 31^{1/2}** d. **80 / 31^{1/2}** h. **105 / 41^{1/4}**
weight: **33 kg / 72,8 lbs**

MATERIAL: Aluminum, Stainless Steel

Coffee Tables

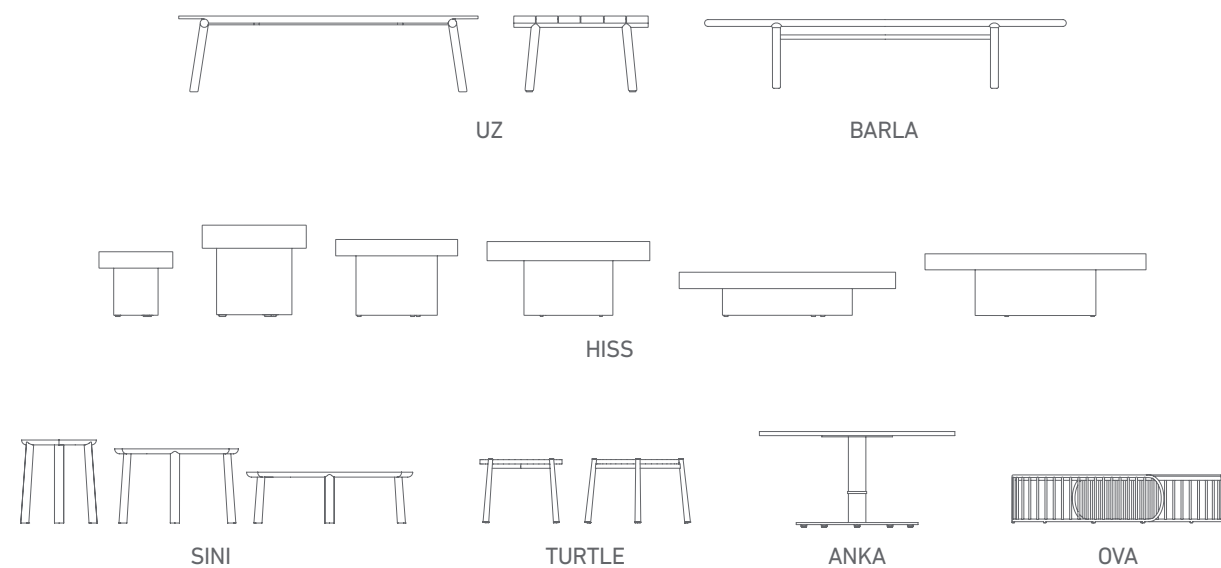

Uz.32.140

Also ideal for contract use, the UZ coffee table, which is available in two different sizes: 140x62cm (55¹/₈ x 24²/₅ inch) and 62x62 cm (24²/₅ x 24²/₅ inch). Structure is made of original teak wood.

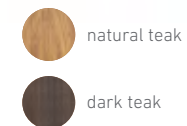
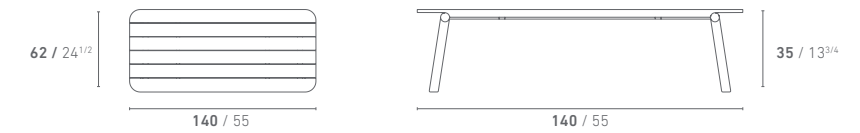

DIMENSIONS
product cm / inch: w. **140 / 55** d. **62 / 24¹/₂** h. **35 / 13³/₄**
weight: **22 kg / 48,5 lbs**

MATERIAL: Teak

Uz.32.62

Also ideal for contract use, the UZ coffee table, which is available in two different sizes: 140x62cm (55¹/₈ x 24²/₅ inch) and 62x62 cm (24²/₅ x 24²/₅ inch). Structure is made of original teak wood.

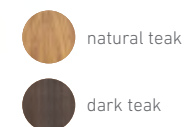
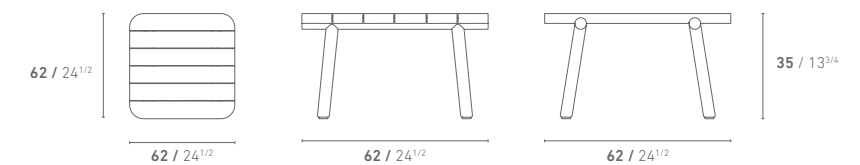

DIMENSIONS
product cm / inch: w. **62 / 24¹/₂** d. **62 / 24¹/₂** h. **35 / 13³/₄**
weight: **12,2 kg / 26,9 lbs**

MATERIAL: Teak

Barla.32.ment - Barla.32.z-pact

The interpenetration of shapes on the BARLA table top arises from the observation of new behaviors and ways of use. It emphasizes the possibility of experiencing several functions at the same time such as working, eating, and playing.

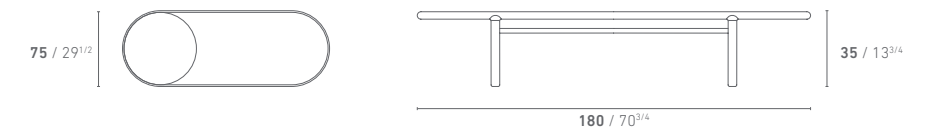

DIMENSIONS
product cm / inch: w. **180 / 70³/₄** d. **75 / 29¹/₂** h. **35 / 13³/₄**
weight: **39,4 kg / 86,9 lbs / 32,4 kg / 71,4 lbs**

MATERIAL: Aluminum, Ment / Z-pact (optional)

Service Top Alternatives
•z-pact
•ment

Hiss.32.R37

The overall structure of the coffee tables is made of aluminum and covered with handmade traditional porcelain. Also ideal for contract use, the HISS coffee tables, which is available in two different sizes. The different heights allow for rich combinations.

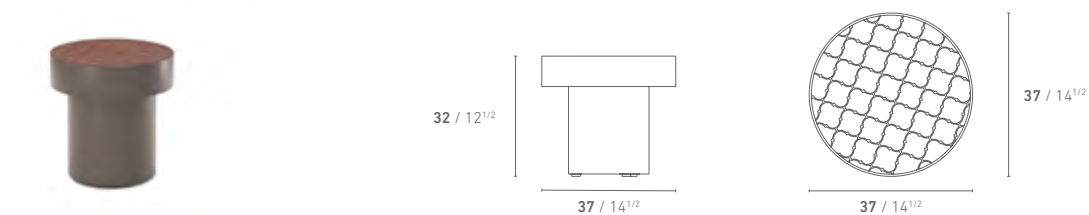

DIMENSIONS
product cm / inch: Ø. 37 / 14^{1/2} h. 32 / 12^{1/2}
weight: 7,8 kg / 17,2 lbs

MATERIAL: Aluminum, porcelain

Hiss.32.R45

The overall structure of the coffee tables is made of aluminum and covered with handmade traditional porcelain. Also ideal for contract use, the HISS coffee tables, which is available in two different sizes. The different heights allow for rich combinations.

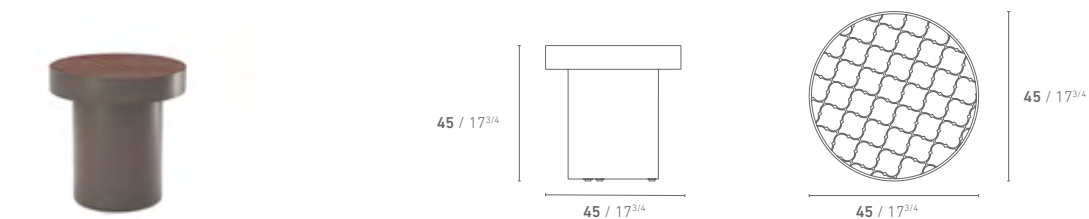

DIMENSIONS
product cm / inch: Ø. 45 / 17^{3/4} h. 45 / 17^{3/4}
weight: 12,2 kg / 26,9 lbs

MATERIAL: Aluminum, porcelain

Hiss.32.R60

The overall structure of the coffee tables is made of aluminum and covered with handmade traditional porcelain. Also ideal for contract use, the HISS coffee tables, which is available in two different sizes. The different heights allow for rich combinations.

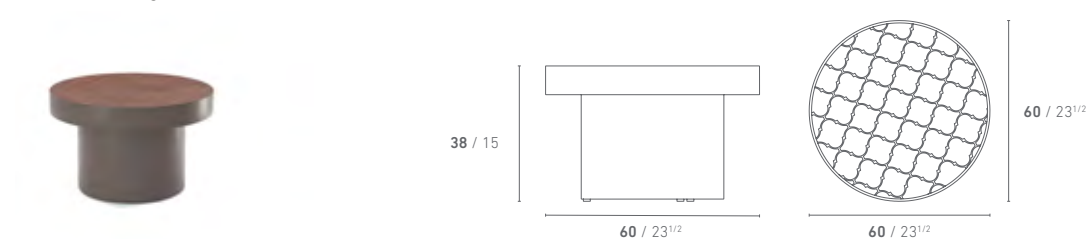

DIMENSIONS
product cm / inch: Ø. 60 / 23^{1/2} h. 38 / 15
weight: 19,6 kg / 43,2 lbs

MATERIAL: Aluminum, porcelain

Hiss.32.R80

The overall structure of the coffee tables is made of aluminum and covered with handmade traditional porcelain. Also ideal for contract use, the HISS coffee tables, which is available in two different sizes. The different heights allow for rich combinations.

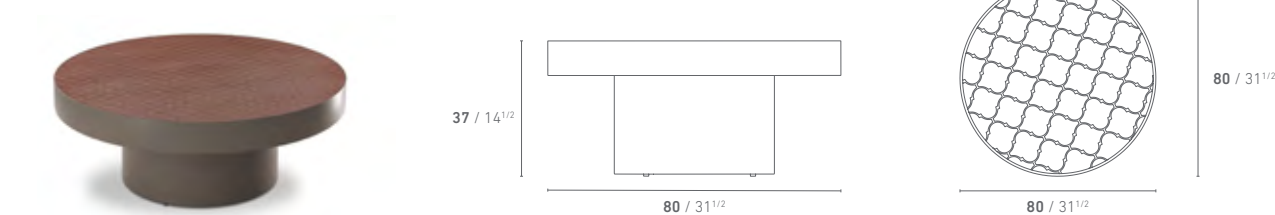

DIMENSIONS
product cm / inch: Ø. 80 / 31^{1/2} h. 37 / 14^{1/2}
weight: 27,8 kg / 61,3 lbs

MATERIAL: Aluminum, porcelain

Hiss.32.R100

The overall structure of the coffee tables is made of aluminum and covered with handmade traditional porcelain. Also ideal for contract use, the HISS coffee tables, which is available in two different sizes. The different heights allow for rich combinations.

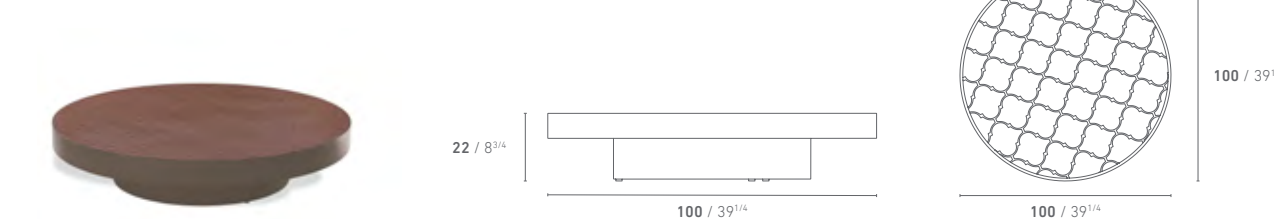

DIMENSIONS
product cm / inch: Ø. 100 / 39^{1/4} h. 22 / 8^{3/4}
weight: 44,8 kg / 98,80 lbs

MATERIAL: Aluminum, porcelain

Hiss.R110

The overall structure of the coffee tables is made of aluminum and covered with handmade traditional porcelain. Also ideal for contract use, the HISS coffee tables, which is available in two different sizes. The different heights allow for rich combinations.

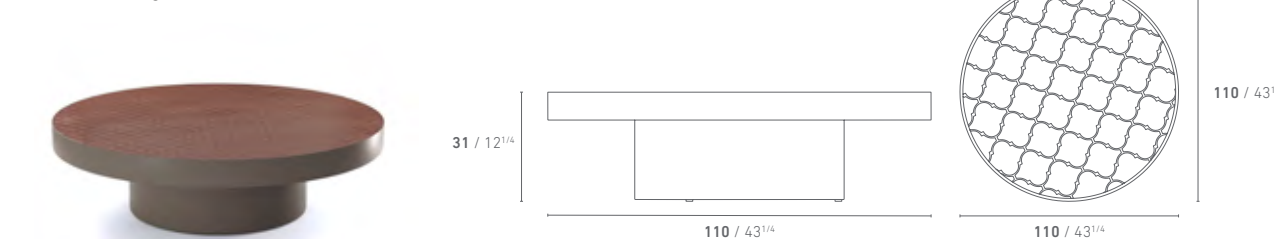

DIMENSIONS
product cm / inch: Ø. 110 / 43^{1/4} h. 31 / 12^{1/4}
weight: 46,2 kg / 101,9 lbs

MATERIAL: Aluminum, porcelain

Sini.32.R45

Also ideal for contract use, the SINI coffee table, which is available in two different sizes: Ø45 / 17^{3/4}, Ø75 / 29^{1/2}, Ø100 / 39^{1/4}.

The structure of the coffee table is made of natural teak wood and the top table is designed as perforated between two glasses.

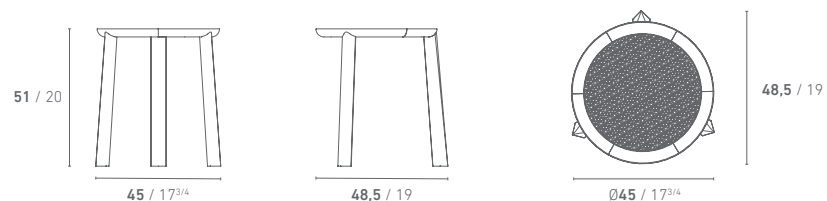

DIMENSIONS

product cm / inch: w. **45 / 17^{3/4}** d. **48,5 / 19** h. **51 / 20**
weight: **5,2 kg / 11,46 lbs**

MATERIAL: Teak, perforated sheet, glass

Sini.32.R75

Also ideal for contract use, the SINI coffee table, which is available in two different sizes: Ø45 / 17^{3/4}, Ø75 / 29^{1/2}, Ø100 / 39^{1/4}.

The structure of the coffee table is made of natural teak wood and the top table is designed as perforated between two glasses.

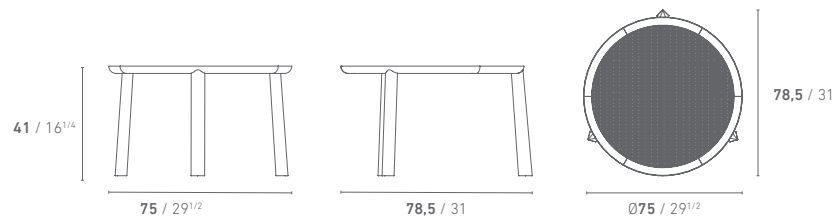

DIMENSIONS

product cm / inch: w. **75 / 29^{1/2}** d. **78,5 / 31** h. **41 / 16^{1/4}**
weight: **12 kg / 26,5 lbs**

MATERIAL: Teak, perforated sheet, glass

Sini.32.R100

Also ideal for contract use, the SINI coffee table, which is available in two different sizes: Ø45 / 17^{3/4}, Ø75 / 29^{1/2}, Ø100 / 39^{1/4}.

The structure of the coffee table is made of natural teak wood and the top table is designed as perforated between two glasses.

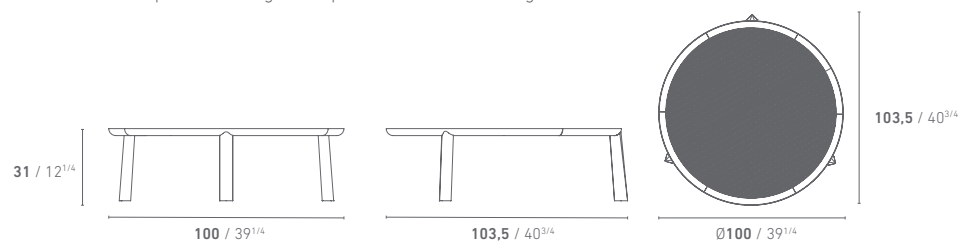

DIMENSIONS

product cm / inch: w. **100 / 39^{1/4}** d. **103,5 / 40^{3/4}** h. **31 / 12^{1/4}**
weight: **19,8 kg / 43,7 lbs**

MATERIAL: Teak, perforated sheet, glass

Turtle.32.SQ - Turtle.32.SQ.z-pact

Also ideal for contract use, the TURTLE coffee table, which is available in two different sizes:

57x57cm (22^{1/2} x 22^{1/2} inch) and Ø 57 cm (Ø 22^{1/2} inch). The table is made entirely of aluminum or HPL making it light weight and durable.

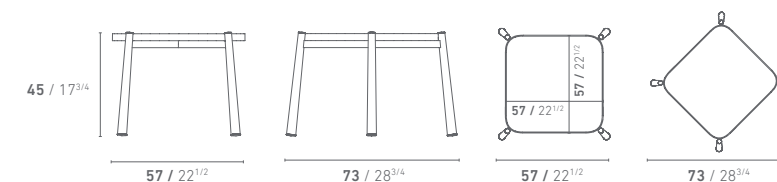

DIMENSIONS

product cm / inch: w. **57 / 22^{1/2}** d. **73 / 28^{3/4}** h. **45 / 17^{3/4}**
weight: **6,2 kg / 13,7 lbs / 8,5 kg / 18,74 lbs**

MATERIAL: Aluminum, Z-pact (optional)

Table Top Alternatives

•z-pact

Turtle.32.R57 - Turtle.32.R57.z-pact

Also ideal for contract use, the TURTLE coffee table, which is available in two different sizes:

57x57cm (22^{1/2} x 22^{1/2} inch) and Ø 57 cm (Ø 22^{1/2} inch). The table is made entirely of aluminum or HPL making it light weight and durable.

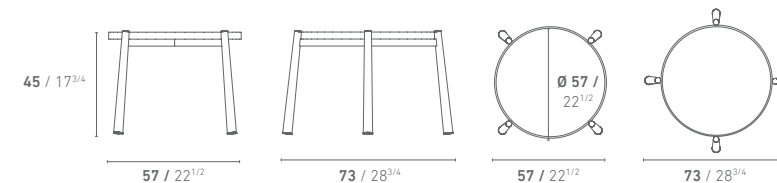

DIMENSIONS

product cm / inch: w. **57 / 22^{1/2}** d. **73 / 28^{3/4}** h. **45 / 17^{3/4}**
weight: **6,2 kg / 13,7 lbs / 8,5 kg / 18,74 lbs**

MATERIAL: Aluminum, Z-pact (optional)

Table Top Alternatives

•z-pact

Anka.32

Anka coffee table leg, which consists of 3 pieces, can be configured with different color combinations. The part that sits on the base is made of heavy-duty stain-less material that is resistant to weather conditions. Aluminum, z-pact and pavement alternatives are available for the table.

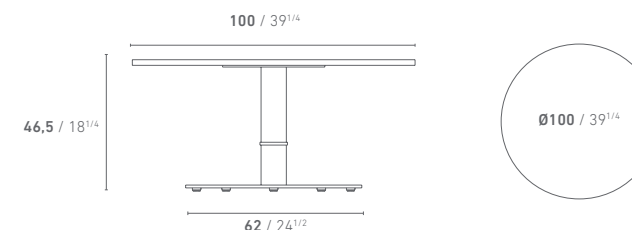

DIMENSIONS

product cm / inch: w. **100 / 39^{1/4}** d. **100 / 39^{1/4}** h. **46,5 / 18^{1/4}**
weight with
alu top: **33 kg / 72,8 lbs**
z-pact top: **40,5 kg / 89,3 lbs**
ment top: **75 kg / 165,30 lbs**

MATERIAL: Aluminum, Z-pact (optional), Ment (optional)

Table Top Alternatives

•z-pact
•ment

Ova.32.AA

Complementing the collection are the coffee tables and tables with the possibility of diversity. Ment or Z-pact...
OVA coffee tables have 2 different structures; Aluminum+Rope and Rope+Rope.

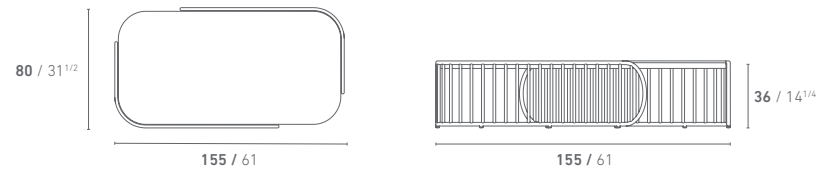

DIMENSIONS

product cm / inch: w. **155 / 61** d. **80 / 31^{1/2}** h. **36 / 14^{1/4}**
weight: z-pact top: **58,7 kg / 129,4 lbs** - ment top: **81,2 kg / 179,0 lbs**

MATERIAL: Aluminum, Z-pact / ment (optional)

Table Top Alternatives

- z-pact
- ment

Ova.32.AR

Complementing the collection are the coffee tables and tables with the possibility of diversity. Ment or Z-pact...
OVA coffee tables have 2 different structures; Aluminum+Rope and Rope+Rope.

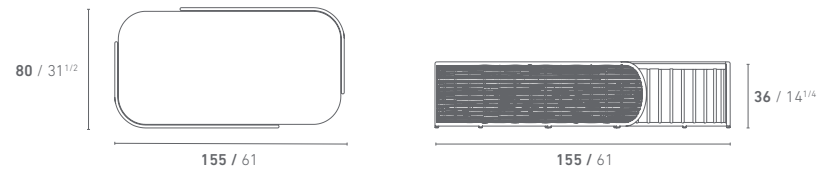

DIMENSIONS

product cm / inch: w. **155 / 61** d. **80 / 31^{1/2}** h. **36 / 14^{1/4}**
weight: z-pact top: **60,5 kg / 133,4 lbs** - ment top: **83 kg / 183,0 lbs**

MATERIAL: Aluminum, Z-pact / ment (optional)

Table Top Alternatives

- z-pact
- ment

Stools

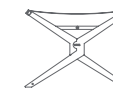

SAYE

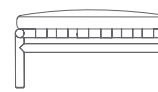
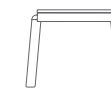

UZ

Saye.14

The functionality of saving space by making the stool foldable and therefore easily transportable and storable is brilliantly resolved by the die-cast aluminum which designs the opening and closing joint of the seat with great lightness.

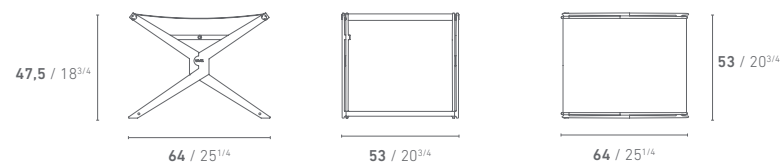

*removable case:
only Serge Ferrari sling fabric is used



special locking mechanism

DIMENSIONS

product cm / inch: w. 64 / 25¹/₄ d. 53 / 20³/₄ h. 47,5 / 18³/₄
weight: 5 kg / 11,0 lbs

MATERIAL: Aluminum, Elios Sling

Uz.14

Structure is made of original teak wood.

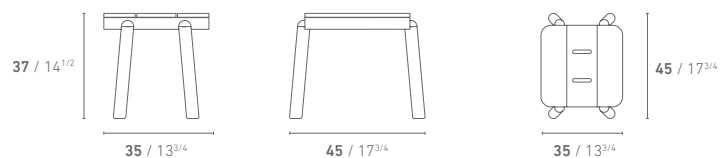

 natural teak

 dark teak

DIMENSIONS

product cm / inch: w. 45 / 17³/₄ d. 35 / 13³/₄ h. 37 / 14¹/₂
weight: 8,6 kg / 19,0 lbs

MATERIAL: Teak, Cushion (optional)

Uz.14.Footrest

Structure is made of original teak wood.

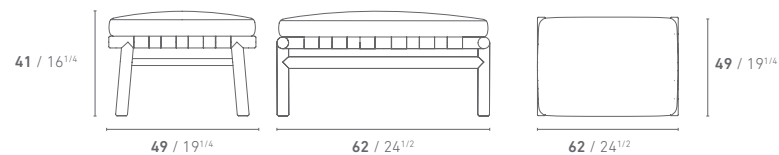

 natural teak

 dark teak

DIMENSIONS

product cm / inch: w. 62 / 24¹/₂ d. 49 / 19¹/₄ h. 41 / 16¹/₄
weight: 4,5 kg / 9,9 lbs

MATERIAL: Teak, Band, Fabric, Foam

Gazebo

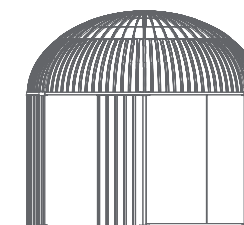

FESS

Fess.54

The entire frame is made of 7001 series aluminum used in the defense industry. It is shipped in 3 pieces and disassembled in a protective crate. It is formed by combining tulle curtain, rope curtain, aluminum perforation and aluminum slats. The aluminum cages on its dome are closed with decorative ropes. It can be manufactured in all aluminum colors.

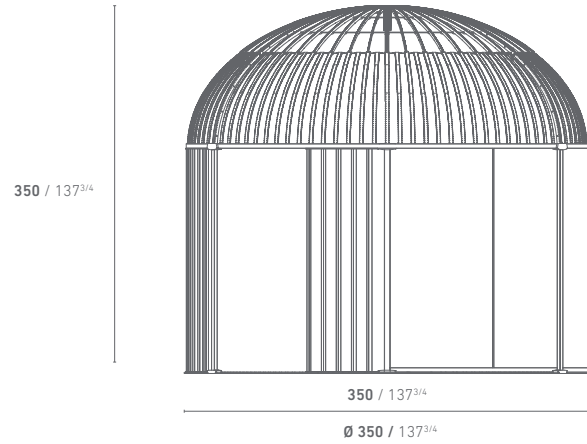

DIMENSIONS

product cm / inch: w. 350 / 137^{3/4} d. 350 / 137^{3/4} h. 350 / 137^{4/5}
weight: 320 kg / 705,48 lbs

MATERIAL: Aluminum, Rope, Perforated Sheet, Fabric

Modular Elements

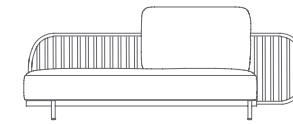

STRAIGHT ENDING: OVA1

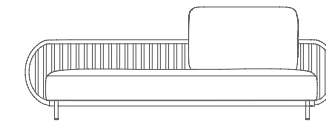

MIDDLE: OVA2 - OVA7 - OVA8

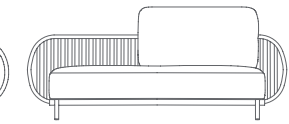

ENDING: OVA5 - OVA6

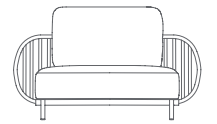

CORNER: OVA3 - OVA4

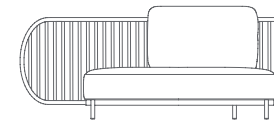

OVA BACKLESS92 - BACKLESS150

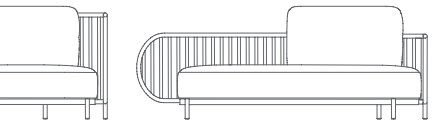
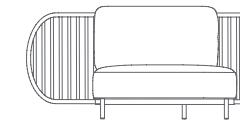
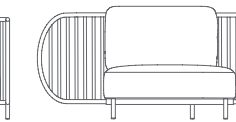

RASEL

OVA1

OVA is a modular seating system that furnishes the exterior of the home as a natural extension of the interior. Infinite variations by overlapping different textures, different height backrests and different materials. OVA1 has three different variations for the backrest..

OVA1.A



OVA1.R



OVA1.P



DIMENSIONS

product cm / inch: w. **207 / 81^{1/2}** d. **100 / 39^{1/4}** h. **83 / 32^{3/4}**

weight:

backrest alu: 43,7 kg / 96,3 lbs

backrest rope: 42,6 kg / 93,9 lbs

backrest perfor: 44,8 kg / 98,8 lbs

MATERIAL: Aluminum, Fabric, Foam, Rope and Perforated Sheet optional

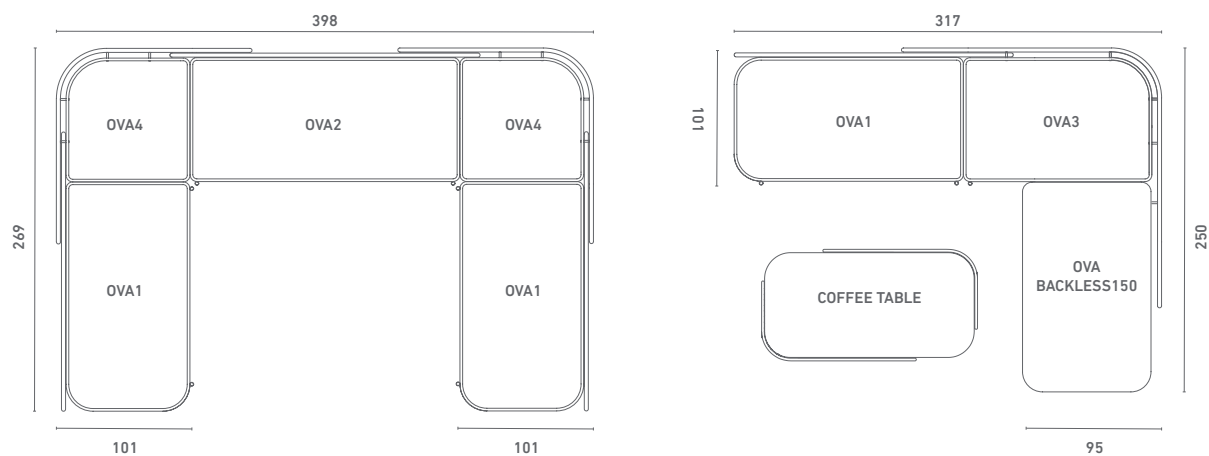
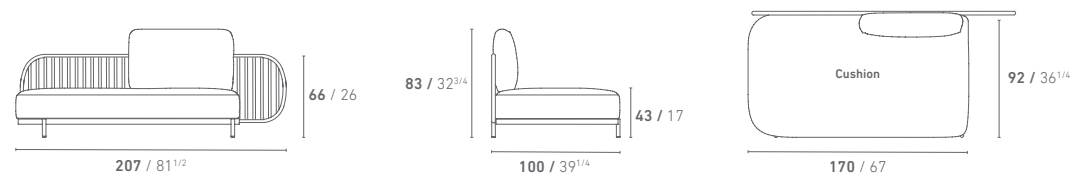

* It is recommended to use OVA1 only as a finishing element.

**Ending elements can be customized as left and right.

***The combinations shown on this page are examples.

You can make various combinations with Ova modular elements. You can get information from our sales team for other options that may be suitable for your project and get technical support for project planning.

OVA2

OVA is a modular seating system that furnishes the exterior of the home as a natural extension of the interior. Infinite variations by overlapping different textures, different height backrests and different materials. OVA2 has three different variations for the backrest..

OVA2.A



OVA2.R



OVA2.P



DIMENSIONS

product cm / inch: w. **230 / 90^{1/2}** d. **100 / 39^{1/4}** h. **83 / 32^{3/4}**

weight:

backrest alu: 49,2 kg / 108,5 lbs

backrest rope: 46,1 kg / 101,6 lbs

backrest perfor: 48,3 kg / 106,5 lbs

MATERIAL: Aluminum, Fabric, Foam, Rope and Perforated Sheet optional

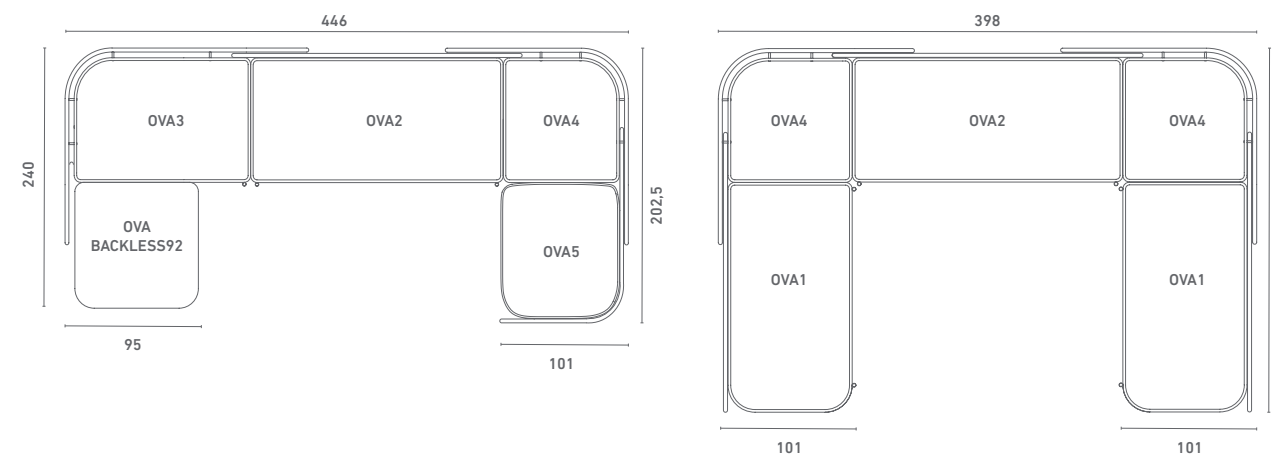
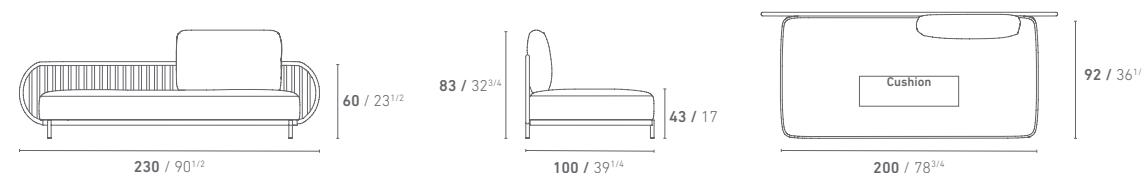

* It is recommended to use OVA2 only as a middle element.

**Ending elements can be customized as left and right.

***The combinations shown on this page are examples.

You can make various combinations with Ova modular elements. You can get information from our sales team for other options that may be suitable for your project and get technical support for project planning.

OVA3

OVA is a modular seating system that furnishes the exterior of the home as a natural extension of the interior. Infinite variations by overlapping different textures, different height backrests and different materials. OVA1 has three different variations for the backrest..

OVA3.A



OVA3.R



DIMENSIONS

product cm / inch: w. 193 / 76 d. 145 / 57 h. 93 / 36^{1/2}

weight:

backrest alu: 34,4 kg / 75,8 lbs

backrest rope: 37,8 kg / 83,3 lbs

MATERIAL: Aluminum, Fabric, Foam, Rope (optional)

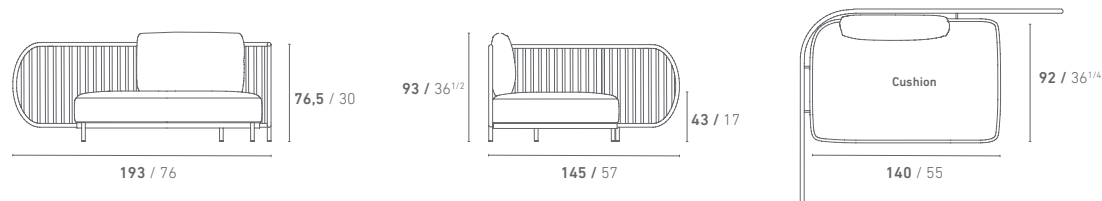

OVA4

OVA is a modular seating system that furnishes the exterior of the home as a natural extension of the interior. Infinite variations by overlapping different textures, different height backrests and different materials. OVA1 has three different variations for the backrest..

OVA4.A



OVA4.R



DIMENSIONS

product cm / inch: w. 145 / 57 d. 145 / 57 h. 93 / 36^{1/2}

weight:

backrest alu: 32,8 kg / 72,3 lbs

backrest rope: 35,6 kg / 78,5 lbs

MATERIAL: Aluminum, Fabric, Foam, Rope (optional)

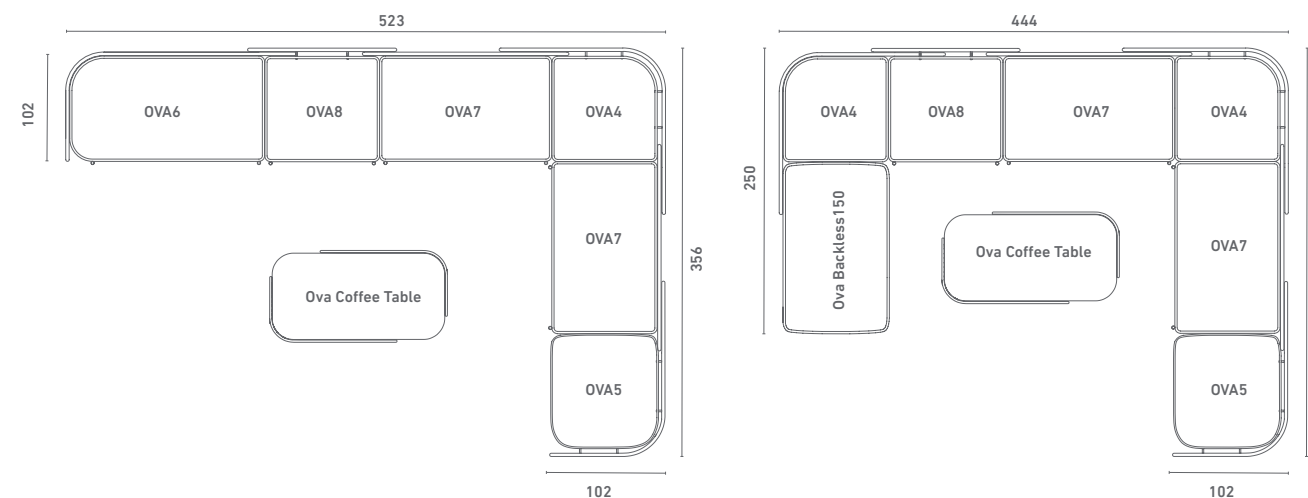
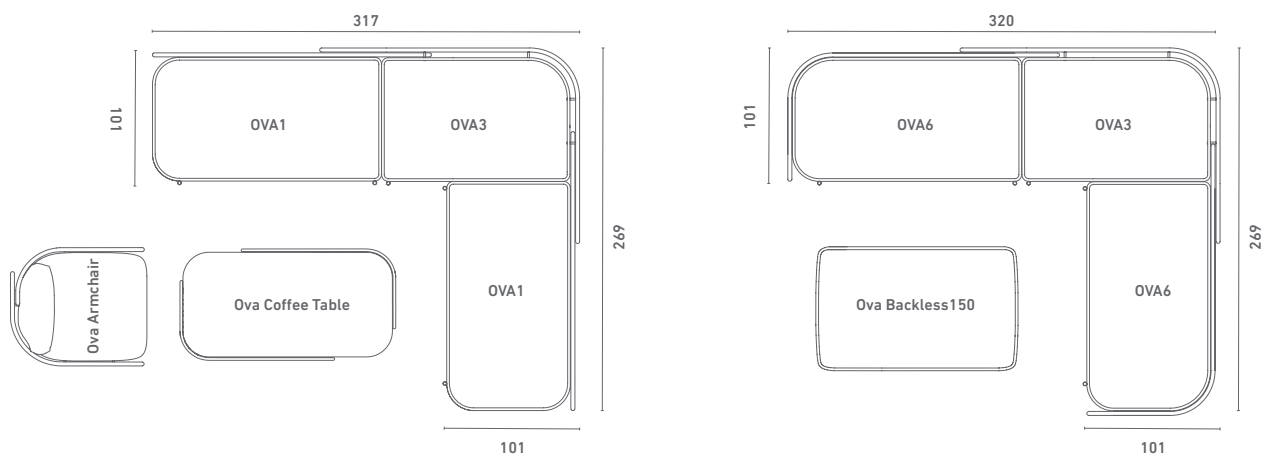
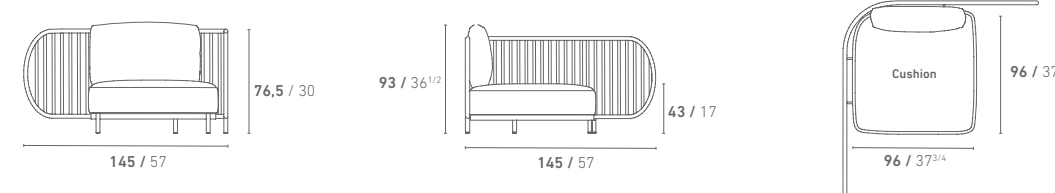

* It is recommended to use OVA3 only as a corner element.

**Ending elements can be customized as left and right.

***The combinations shown on this page are examples.

You can make various combinations with Ova modular elements. You can get information from our sales team for other options that may be suitable for your project and get technical support for project planning.



* It is recommended to use OVA4 only as a corner element.

**Ending elements can be customized as left and right.

***The combinations shown on this page are examples.

You can make various combinations with Ova modular elements. You can get information from our sales team for other options that may be suitable for your project and get technical support for project planning.

OVA5

OVA is a modular seating system that furnishes the exterior of the home as a natural extension of the interior. Infinite variations by overlapping different textures, different height backrests and different materials. OVA1 has three different variations for the backrest..

OVA5.A



OVA5.R



DIMENSIONS

product cm / inch: w. 153 / 60^{1/4} d. 100 / 39^{1/4} h. 93 / 36^{1/2}

weight:

backrest alu: 33,6 kg / 74,1 lbs

backrest rope: 37 kg / 81,6 lbs

MATERIAL: Aluminum, Fabric, Foam, Rope (optional)

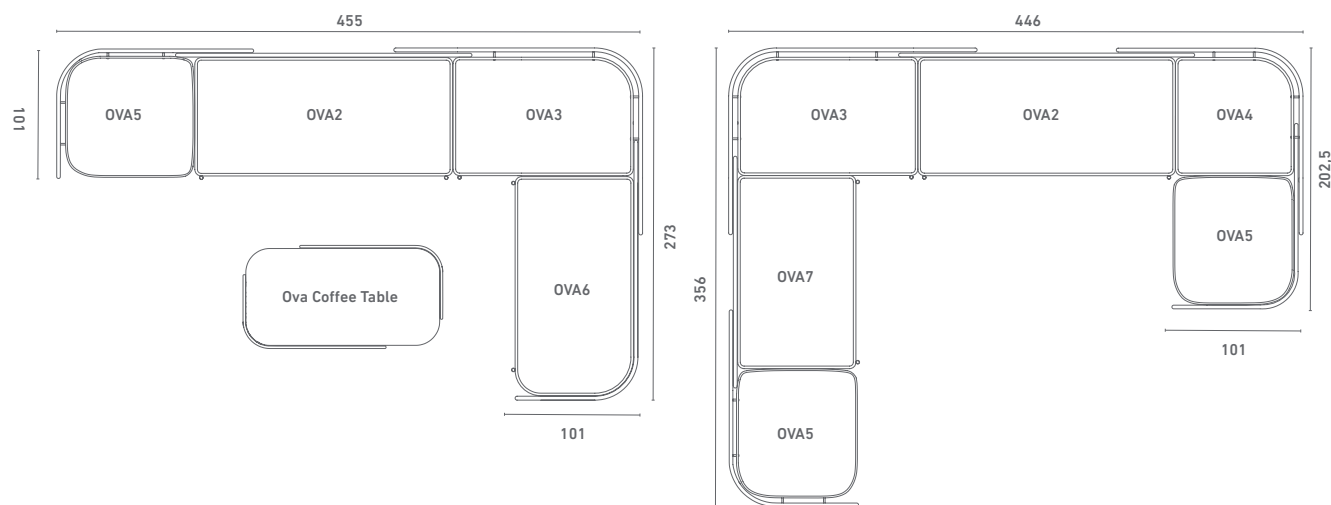
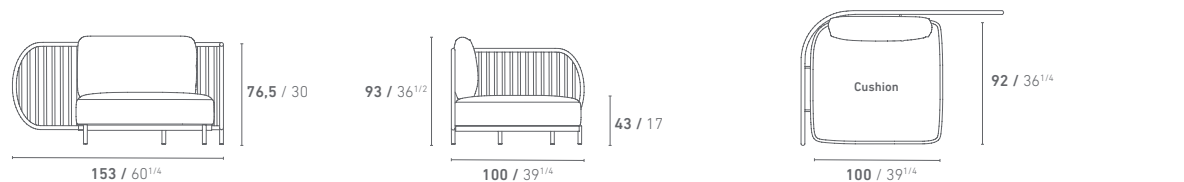

* It is recommended to use OVA5 only as a corner element.

**Ending elements can be customized as left and right.

***The combinations shown on this page are examples.

You can make various combinations with Ova modular elements. You can get information from our sales team for other options that may be suitable for your project and get technical support for project planning.

OVA6

OVA is a modular seating system that furnishes the exterior of the home as a natural extension of the interior. Infinite variations by overlapping different textures, different height backrests and different materials. OVA1 has three different variations for the backrest..

OVA6.A



OVA6.R



DIMENSIONS

product cm / inch: w. 201 / 79^{1/4} d. 100 / 39^{1/4} h. 83 / 32^{3/4}

weight:

backrest alu: 35,8 kg / 78,9 lbs

backrest rope: 37,4 kg / 82,5 lbs

MATERIAL: Aluminum, Fabric, Foam, Rope (optional)

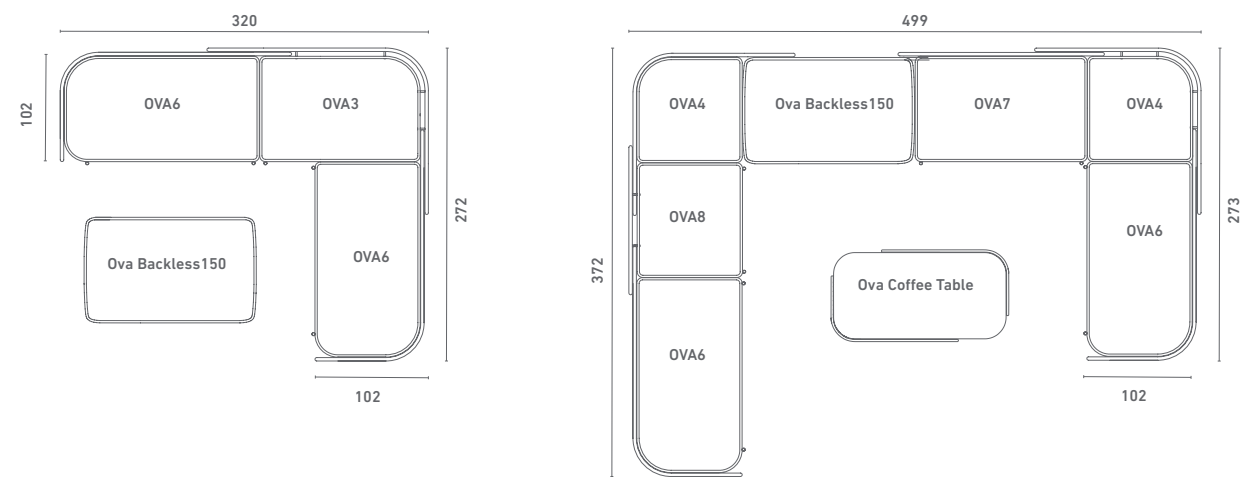
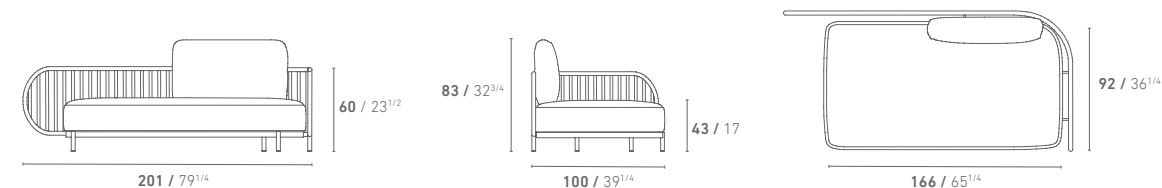

* It is recommended to use OVA6 only as an ending element.

**Ending elements can be customized as left and right.

***The combinations shown on this page are examples.

You can make various combinations with Ova modular elements. You can get information from our sales team for other options that may be suitable for your project and get technical support for project planning.

OVA7

OVA is a modular seating system that furnishes the exterior of the home as a natural extension of the interior. Infinite variations by overlapping different textures, different height backrests and different materials. OVA1 has three different variations for the backrest..

OVA7.A



OVA7.R



OVA7.P



DIMENSIONS

product cm / inch: w. **180 / 70^{3/4}** d. **100 / 39^{1/4}** h. **83 / 32^{3/4}**

weight:

backrest alu: **39 kg / 86,0 lbs**

backrest rope: **39,4 kg / 86,9 lbs**

backrest performe: **40,8 kg / 89,9 lbs**

MATERIAL: Aluminum, Fabric, Foam, Rope and Perforated Sheet optional

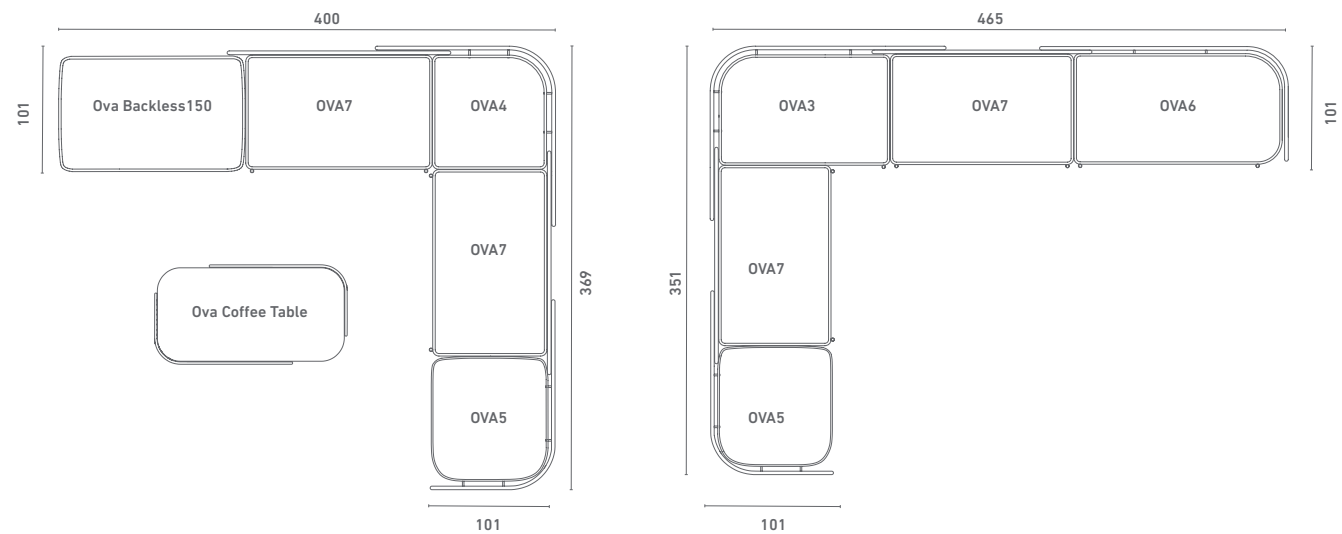
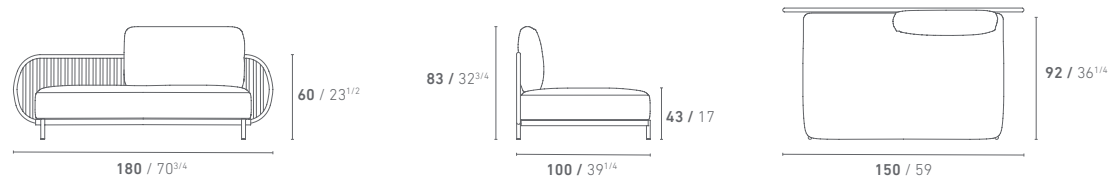

* It is recommended to use OVA7 only as a middle element.

**Ending elements can be customized as left and right.

***The combinations shown on this page are examples.

You can make various combinations with Ova modular elements. You can get information from our sales team for other options that may be suitable for your project and get technical support for project planning.

OVA8

OVA is a modular seating system that furnishes the exterior of the home as a natural extension of the interior. Infinite variations by overlapping different textures, different height backrests and different materials. OVA1 has three different variations for the backrest..

OVA8.A



OVA8.R



OVA8.P



DIMENSIONS

product cm / inch: w. **127 / 50** d. **100 / 39^{1/4}** h. **83 / 32^{3/4}**

weight:

backrest alu: **25,6 kg / 56,4 lbs**

backrest rope: **24,7 kg / 54,5 lbs**

backrest performe: **28 kg / 61,7 lbs**

MATERIAL: Aluminum, Fabric, Foam, Rope and Perforated Sheet optional

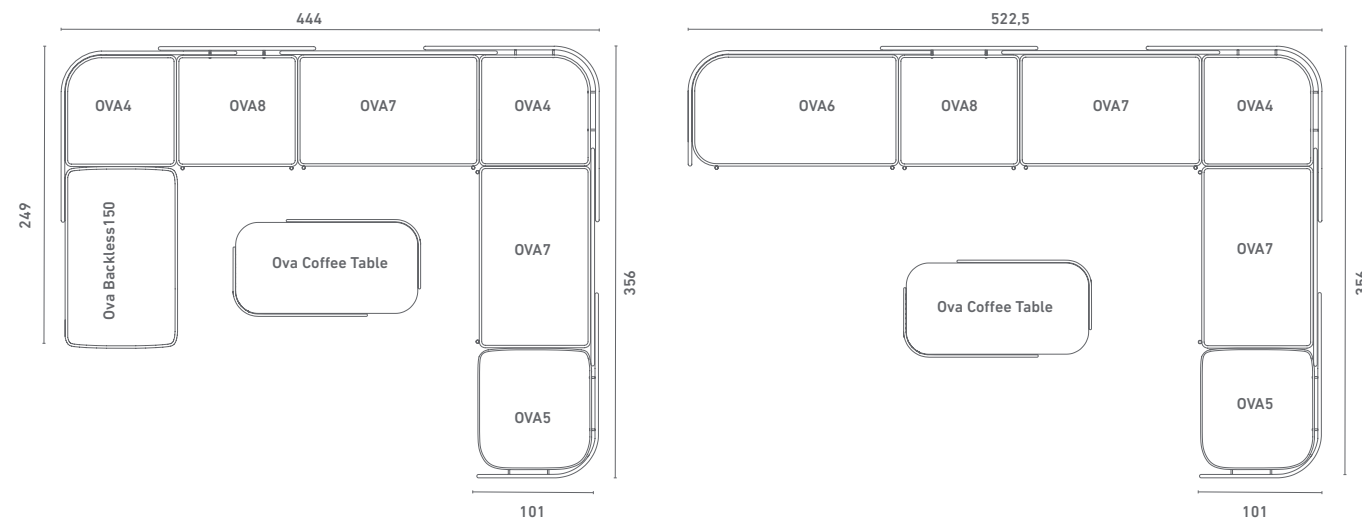
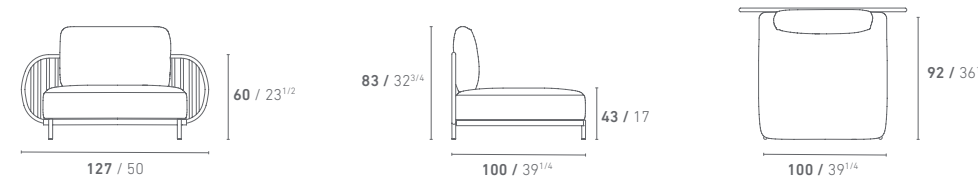

* It is recommended to use OVA8 only as a middle element.

**Ending elements can be customized as left and right.

***The combinations shown on this page are examples.

You can make various combinations with Ova modular elements. You can get information from our sales team for other options that may be suitable for your project and get technical support for project planning.

Ova.Backless.92

OVA is a modular seating system that furnishes the exterior of the home as a natural extension of the interior. Infinite variations by overlapping different textures, different height backrests and different materials. OVA1 has three different variations for the backrest.

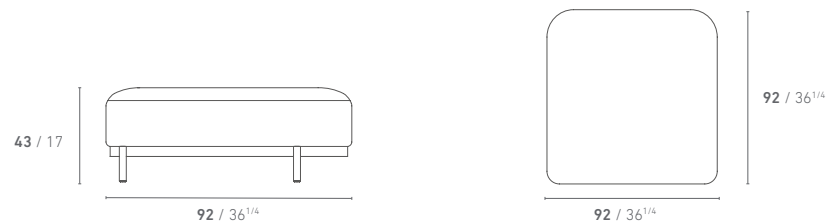

DIMENSIONS
product cm / inch: w. 92 / 36^{1/4} d. 92 / 36^{1/4} h. 43 / 17
weight: 27 kg / 59,52 lbs

MATERIAL: Aluminum, Fabric, Foam

Ova.Backless.150

OVA is a modular seating system that furnishes the exterior of the home as a natural extension of the interior. Infinite variations by overlapping different textures, different height backrests and different materials. OVA1 has three different variations for the backrest.

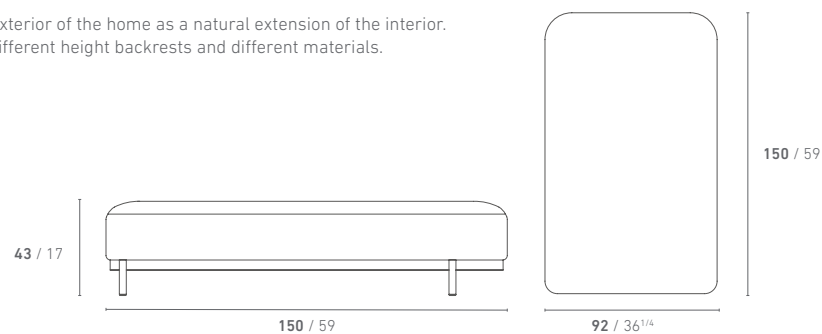

DIMENSIONS
product cm / inch: w. 150 / 59 d. 92 / 36^{1/4} h. 43 / 17
weight: 29,4 kg / 64,82 lbs

MATERIAL: Aluminum, Fabric, Foam

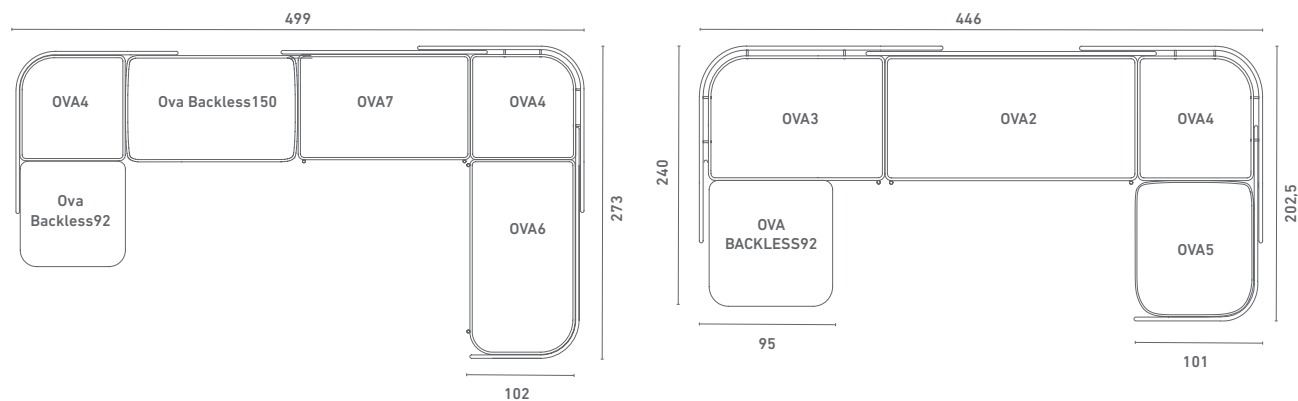

* Backless parts can be used alone or side by side with other modular elements.
**Ending elements can be customized as left and right.
***The combinations shown on this page are examples.
You can make various combinations with Ova modular elements. You can get information from our sales team for other options that may be suitable for your project and get technical support for project planning.

Rasel.16.Small

The entire frame is made of 7001 series aluminum used in the defense industry. It is easy to transport and install with its modular structure. It can be planned inside FESS or separately for indoor and outdoor spaces.



ATTENTION!
The product is a modular part of the Rasel Sofa.

DIMENSIONS
product cm / inch: w. 125 / 49^{1/4} d. 84 / 33 h. 71,5 / 28^{1/4}
weight: 27,5 kg / 60,6 lbs

MATERIAL: Aluminum, Teak, Fabric, Foam

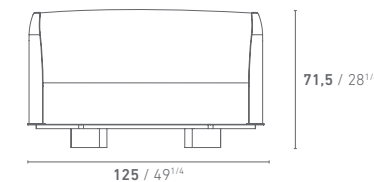

Rasel.16.Large

The entire frame is made of 7001 series aluminum used in the defense industry. It is easy to transport and install with its modular structure. It can be planned inside FESS or separately for indoor and outdoor spaces.



ATTENTION!
The product is a modular part of the Rasel Sofa.

DIMENSIONS
product cm / inch: w. 229 / 90^{1/4} d. 84 / 33 h. 71,5 / 28^{1/4}
weight: 41 kg / 90,4 lbs

MATERIAL: Aluminum, Teak, Fabric, Foam

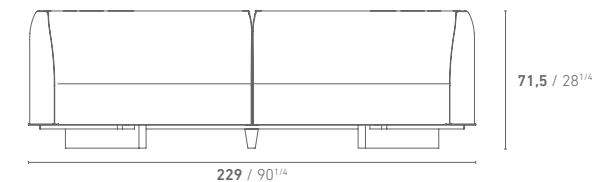

Rasel.16.Small

Rasel.16.Large



Complements

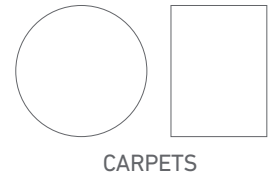

CARPETS



FIRE PIT



SWING



FLOWER POTS



LIGHTING



DECORATIVE CUSHIONS

Yunn.52.R220

Made from sustainable YaaZ Rope that do not use water in their production. Available in 6 sizes in 5 different models.

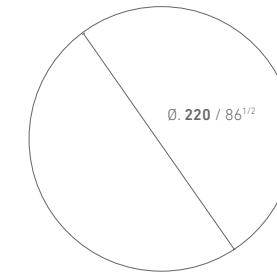

DIMENSIONS
product cm / inch: Ø. 220 / 86^{1/2}
MATERIAL: Rope



Only 4 colors are used in the production of carpets

Yunn.52.R240

Made from sustainable YaaZ Rope that do not use water in their production. Available in 6 sizes in 5 different models.

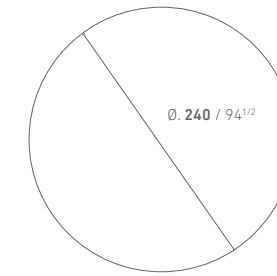

DIMENSIONS
product cm / inch: Ø. 240 / 94^{1/2}
MATERIAL: Rope

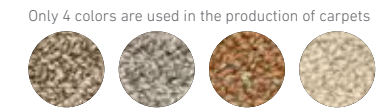

Only 4 colors are used in the production of carpets

Yunn.52.R350

Made from sustainable YaaZ Rope that do not use water in their production. Available in 6 sizes in 5 different models.

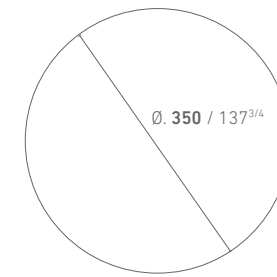

DIMENSIONS
product cm / inch: Ø. 350 / 137^{3/4}
MATERIAL: Rope

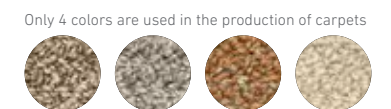

Only 4 colors are used in the production of carpets

Yunn.52.240x320

Made from sustainable Yaaz Rope that do not use water in their production. Available in 6 sizes in 5 different models.

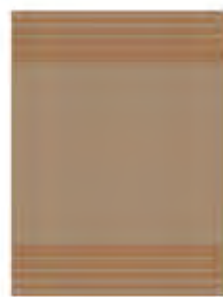

Mod.2

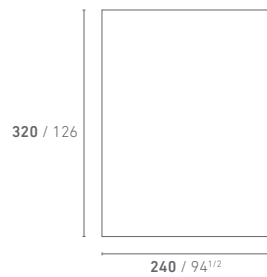

Mod.3



Mod.4



Mod.5

DIMENSIONS
product cm / inch: w. **240 / 94^{1/2}** h. **320 / 126**
MATERIAL: Rope

Only 4 colors are used in the production of carpets

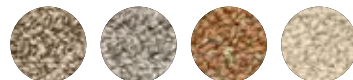

Yunn.52.230x360

Made from sustainable Yaaz Rope that do not use water in their production. Available in 6 sizes in 5 different models.



Mod.2

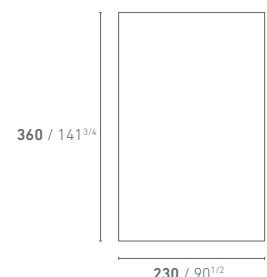

Mod.3



Mod.4



Mod.5

DIMENSIONS
product cm / inch: w. **230 / 90^{1/2}** h. **360 / 141^{3/4}**
MATERIAL: Rope

Only 4 colors are used in the production of carpets

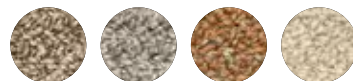

Yunn.52.300x400

Made from sustainable Yaaz Rope that do not use water in their production. Available in 6 sizes in 5 different models.



Mod.2

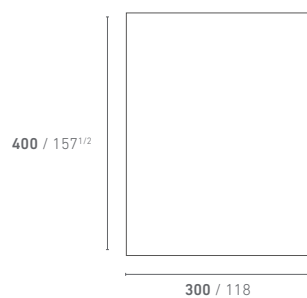

Mod.3



Mod.4



Mod.5

DIMENSIONS
product cm / inch: w. **300 / 118** h. **400 / 157^{1/2}**
MATERIAL: Rope

Only 4 colors are used in the production of carpets

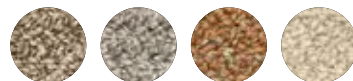

Harr.51.Fire Pit

HARR is a garden fire pit with a dome, made of stainless steel.

The grill cover can be made of pavement, stainless steel or Decorative High Pressure Z-pact (HPL).

The circular shape enhances the atavistic charm of fire, and its sacredness, and offers protection and shelter.

Standard



Z-pact Grill Cover



Ment top Grill Cover



DIMENSIONS
product cm / inch: w. **80 / 31^{1/2}** d. **80 / 31^{1/2}** h. **55 / 21^{3/4}**
weight with
standard: **53,2 kg / 117,3 lbs**
z-pact grill cover: **65,3 kg / 144 lbs**
ment grill cover: **74,8 kg / 164,9 lbs**

Only 7 colors are used in the production of fire pit



MATERIAL: Aluminum, Stainless Steel, Z-pact and Ment optional

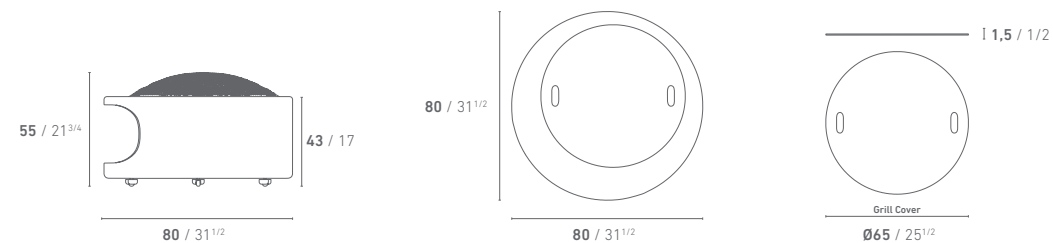

Hayal.19

The structure is made in solid aluminum and the seat is upholstered with fabric, whereas the small tassels embellish its ropes.

With alternatives 18 colors and 4 colors rope.

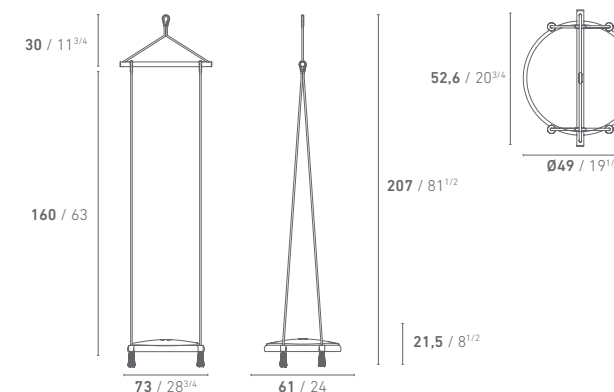

DIMENSIONS
product cm / inch: w. **73 / 28^{3/4}** d. **61 / 24** h. **207 / 81^{1/2}**
weight: **6,3 kg / 13,8 lbs**

MATERIAL: Aluminum, Rope, Fabric, Foam

Kuva.53.R60

Yaaz pot collection is handmade from terracotta. The products, whose basic material is terracotta, are produced in 4 colors and 3 different sizes, carefully selected to match all collections.

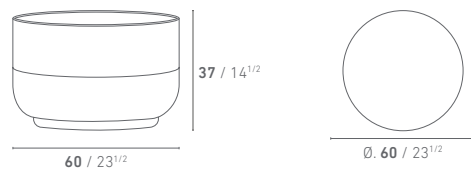

DIMENSIONS
product cm / inch: Ø. 60 / 23^{1/2} h. 37 / 14^{1/2}
weight: 28,8 kg / 63,5 lbs

MATERIAL: Terracotta

Only 4 colors are used in the production of flower pots.



Note: Our products are handmade. There may be slight differences in colors and sizes (0.5-2 cm). These differences do not indicate that the product is defective. It is the feature of being completely handmade.

Kuva.53.R50

Yaaz pot collection is handmade from terracotta. The products, whose basic material is terracotta, are produced in 4 colors and 3 different sizes, carefully selected to match all collections.

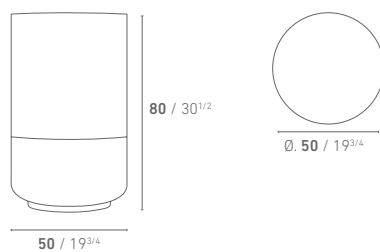

DIMENSIONS
product cm / inch: Ø. 50 / 19^{3/4} h. 80 / 30^{1/2}
weight: 33,2 kg / 73,2 lbs

MATERIAL: Terracotta

Only 4 colors are used in the production of flower pots.



Note: Our products are handmade. There may be slight differences in colors and sizes (0.5-2 cm). These differences do not indicate that the product is defective. It is the feature of being completely handmade.

Kuva.53.R39

Yaaz pot collection is handmade from terracotta. The products, whose basic material is terracotta, are produced in 4 colors and 3 different sizes, carefully selected to match all collections.

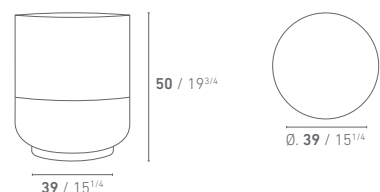

DIMENSIONS
product cm / inch: Ø. 39 / 15^{1/4} h. 50 / 19^{3/4}
weight: 17,2 kg / 37,9 lbs

MATERIAL: Terracotta

Only 4 colors are used in the production of flower pots.



Note: Our products are handmade. There may be slight differences in colors and sizes (0.5-2 cm). These differences do not indicate that the product is defective. It is the feature of being completely handmade.

Manle.57

Manle is a perfect combination of light and manual labor. It combines the transparent elegance of glass with the warm touch of handcrafted knitting threads. Each thread takes shape in the hands of women and is woven with stories. Through a labor network they call the "value chain", these women find a new meaning that touches their lives as individuals left out of the traditional production chain.

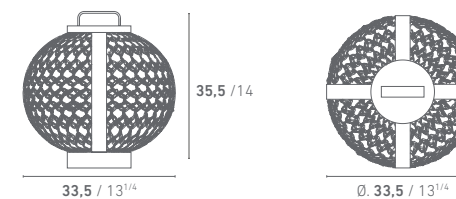

DIMENSIONS
product cm / inch: Ø. 33,5 / 13^{1/4} h. 35,5 / 14
weight: 5,5 kg / 12,1 lbs

MATERIAL: Aluminum, Glass, Rope, Outdoor electric elements

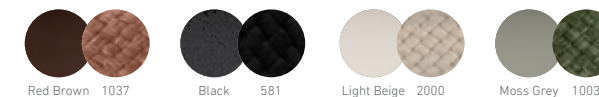

Note: Only 4 colors and 4 ropes are used in the production of Manle Lighting. Only 4 colors and 4 ropes are used in the production of Manle Lighting.

Sweet.55

SWEET is available in six different versions with variations in color and material. In five of these versions, the cushions are covered with SUNBRELLA fabrics on the outside, making them adaptable to all types of products and environments.

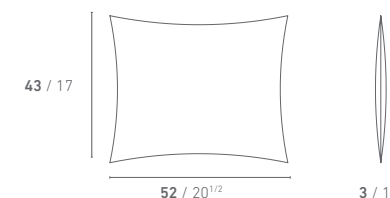

DIMENSIONS
Pillow product cm / inch: w. 52 / 20^{1/2} d. 3 / 1^{1/4} h. 43 / 17
Blanket product cm / inch: w. 157 / 61^{3/4} h. 110 / 43^{1/4}
weight: 1,5 kg / 3,5 lbs

MATERIAL: Fabric, Fiber

SWEET is available in six different versions with variations in color and material. One of the six versions and covered in a fabric printed with the SWEET design also on the outside, making it a unique and characterizing accessory for an environment.

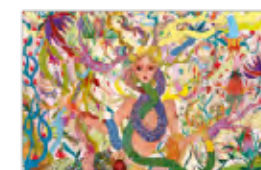
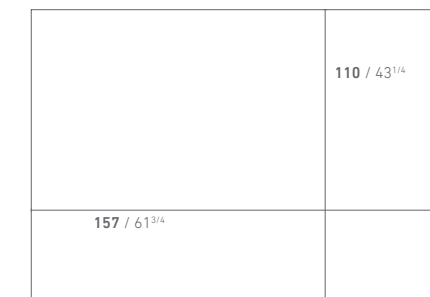

full color version (back)



full color version with a cover flow oak

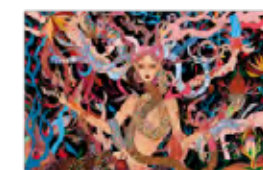

black version (back)



black version with a cover flow pumpkin



gold version (back)



gold version with a cover heritage char



red version (back)



red version with a cover flow sahara



blue version (back)



blue version with a cover flow fusion



blue version (back)

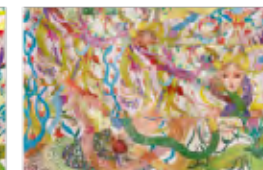

rainbow version with a cover printed with a SWEET design

DECORATIVE CUSHION

Overall, water proof solution fabrics are an excellent choice for outdoor use because they offer protection from water damage and other environmental factors. They are durable, long-lasting, and easy to maintain, making them a practical and functional solution for outdoor furniture, and other outdoor items.

DC.55.40x40

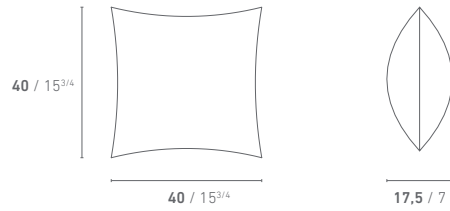

DIMENSIONS

product cm / inch: w. **40 / 15^{3/4}** d. **17,5 / 7** h. **40 / 15^{3/4}**
weight: **0,6 kg / 1,32 lbs**

Cushion Material & Pedding Type

FNS I Standart Foam + Sunbrella Fabric: soft seating

DC.55.30x60

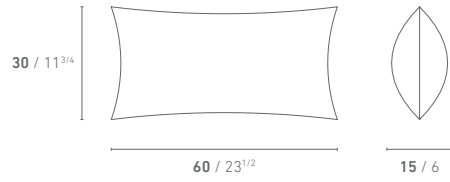

DIMENSIONS

product cm / inch: w. **60 / 23^{1/2}** d. **15 / 6** h. **30 / 11^{3/4}**
weight: **1,1 kg / 2,43 lbs**

Cushion Material & Pedding Type

FNS I Standart Foam + Sunbrella Fabric: soft seating

DC.55.40x60

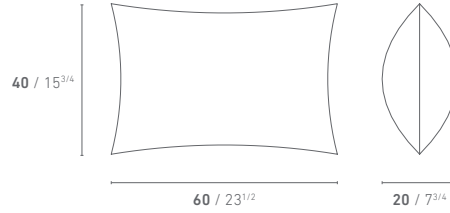

DIMENSIONS

product cm / inch: w. **60 / 23^{1/2}** d. **20 / 7^{3/4}** h. **40 / 15^{3/4}**
weight: **1 kg / 2,20 lbs**

Cushion Material & Pedding Type

FNS I Standart Foam + Sunbrella Fabric: soft seating

DC.55.60x60

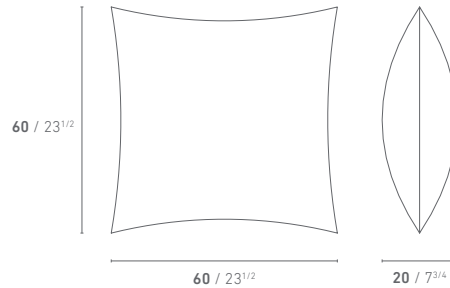

DIMENSIONS

product cm / inch: w. **60 / 23^{1/2}** d. **20 / 7^{3/4}** h. **60 / 23^{1/2}**
weight: **1,1 kg / 2,43 lbs**

Cushion Material & Pedding Type

FNS I Standart Foam + Sunbrella Fabric: soft seating

YAAZ

FOLLOW US



NJ MAIN OFFICE & STORE

151 Route 17 South
Rochelle Park, NJ 07662
T : +1 (201) 250 89 08

KSA AGENCY & STORE

Arcade Center, King Fahad Road
7204, Riyadh
P: +966 (55) 506 7697

CYPRUS AGENCY & STORE

Uğur Mumcu Blv.
Hz.Ömer St. No: 25
Karakum, Girne
P: +90 (546) 993 40 62

FACTORY & SHOWROOM

Karataş Yolu 10.Km. No:832/A
01375 Yüreğir, Adana
T: +90 (322) 232 00 43 - 46

ISTANBUL MAIN OFFICE & SHOWROOM

Yenibosna İstwest Sit. A1 Blok No:17
34197 Bahçelievler, İstanbul
T: +90 (212) 472 22 57 - 58

ROMANIA AGENCY & STORE

Strada Brizei Nr 11 Scara A Lot 1 S 5,
Loc. Navodari , Jud . Constanta
P: +40 799 924 434

yaaz.com

The YAAZ brand and logo are registered trademarks.
YAAZ prohibits the use of its trademarks, logos, domain names, and business name without its consent, even in countries where they are not registered.
All rights not expressly granted are reserved.

AWARDS



Catalog Design : Yaaz Lab & Angeletti Ruzza Design Studio
Art Director : angelettiruzza design
3D Visulation : Abdurrahim Karakoç - Abdulmuttalip Karakoç
Date : 2025 / January

